



晶采光電科技股份有限公司
AMPIRE CO., LTD.

SPECIFICATIONS FOR LCD MODULE

CUSTOMER	
CUSTOMER PART NO.	
AMPIRE PART NO.	AM-640480G2TNQW-A0H
APPROVED BY	
DATE	

Approved For Specifications

Approved For Specifications & Sample

AMPIRE CO., LTD.

2F., No.88, Sec. 1, Sintai 5th Rd., Sijhih City, Taipei County 221, Taiwan (R.O.C.)

台北縣汐止市新台五路一段 88 號 2 樓(東方科學園區 D 棟)

TEL:886-2-26967269 , FAX:886-2-26967196 or 26967270

APPROVED BY	CHECKED BY	ORGANIZED BY

RECORD OF REVISION

Revision Date	Page	Contents	Editor
2009/7/8	--	New Release	JOHN

1. INTRODUCTION

This is a color active matrix TFT-LCD that uses amorphous silicon TFT as a switching device . This model is composed of a 5.7inch TFT-LCD panel , a driving circuit and LED backlight system . This TFT-LCD has a high resolution (640(R.G.B) X 480) and can display up to 262,144 colors.

1-1. Features

- VGA Resolution
- 6 Bits color driver with LVDS interface
- Wide range operation temperature

2. PHYSICAL SPECIFICATIONS

Item	Specifications	unit
Display resolution(dot)	640RGB (W) x 480(H)	dots
Display area	115.2 (W) x 86.4 (H)	mm
Pixel pitch	0.18 (W) x 0.18 (H)	mm
Color configuration	R.G.B Vertical stripe	
Overall dimension	127.0(W)x98.43(H)x7.5(D)---(Typ)	mm
Surface treatment	Antiglare , Hard-Coating(3H)	
Brightness	500	cd/m ²
Contrast ratio	250 : 1	
Backlight unit	LED	
Display color	262,144	colors
Viewing Direction	12 o'clock	
Display Mode	Normally White	

3. ABSOLUTE MAXIMUM RATINGS

ITEM	SYMBOL	MIN	MAX	UNIT	NOTE
Power Supply Voltage	V _{cc}	-0.5	5	V	
Signal Input Voltage	DCLK, DE R0~R5 G0~G5 B0~B5	-0.5	V _{cc} + 0.5	V	
Operation Temperature	Top	-20	70	°C	
Storage Temperature	Tstg	-30	80	°C	

4. ELECTRICAL CHARACTERISTICS

4-1 TFT LCD Module voltage

ITEM	SYMBOL	MIN	TYP	MAX	UNIT	NOTE
Power Voltage For LCD	V _{CC}	3.0	3.3	3.6	V	
Power Voltage For VLED	V _{DD}	--	5.0	--	V	
Logic Input Voltage	V _{IH}	V _{CC} *0.7	--	V _{CC}	V	
	V _{IL}	0	--	V _{CC} *0.3	V	
ADJ Input Voltage	V _{IH}	3.0	--	5.0	V	
	V _{IL}	GND	--	0.3	V	

4-2 TFT LCD current consumption

ITEM	SYMBOL	MIN	TYP	MAX	UNIT	NOTE
LCD Power Current	I _{cc}	-	106	-	mA	(1)
LED Power Current	I _{LED} (V _{LED} =5V)	-	290	-	mA	

NOTE : (1) Typ : under 64 gray pattern Max : under black pattern



(a) 64 Gray Pattern



(b) Black Pattern

6. INTERFACE

LVDS J2:

Pin no	Symbol	Function
1	VDD	POWER SUPPLY:3.3V
2	VDD	POWER SUPPLY:3.3V
3	Gnd	Power Ground
4	Gnd	Power Ground
5	IN0-	Transmission Data of Pixels
6	IN0+	Transmission Data of Pixels
7	Gnd	Power Ground
8	IN1-	Transmission Data of Pixels 1
9	IN1+	Transmission Data of Pixels 1
10	Gnd	Power Ground
11	IN2-	Transmission Data of Pixels 2
12	IN2+	Transmission Data of Pixels 2
13	Gnd	Power Ground
14	CLK-	Sampling Clock
15	CLK+	Sampling Clock
16	Gnd	Power Ground
17	NC	No Connect
18	NC	No Connect
19	Gnd	Power Ground
20	Gnd	Power Ground

LED J3:

Pin no	Symbol	Function
1	GND	Power Ground
2	VLED	Power Supply for LED 5V
3	VLED	Power Supply for LED 5V
4	ADJ	Adjust for LED Brightness *Note

NOTE :

- ADJ adjust brightness to control Pin , Pulse duty the bigger the brighter.

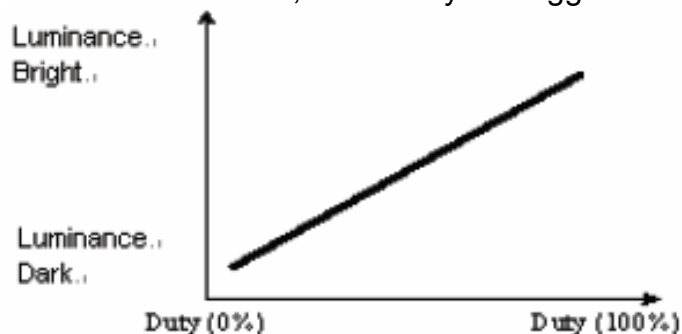

2. ADJ signal = 0 ~ 5.0V , operation frequency : 300Hz~1KHz

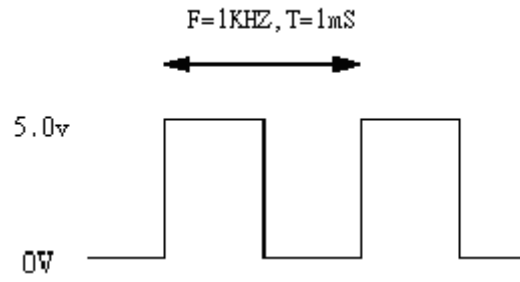

3. VSS Pin must ground contact , can not be floating.

7. AC Timing characteristic of the LVDS

Switching Characteristics

over recommended operating conditions (unless otherwise noted)

PARAMETER	TEST CONDITIONS	MIN	TYP ⁽¹⁾	MAX	UNIT
t_{su}	Setup time, D0–D20 to CLKOUT↓	5			ns
t_h	Data hold time, CLKOUT↓ to D0–D20	5			ns
$t_{(RSKM)}$	Receiver input skew margin ⁽²⁾ (see Figure 7)	550	700		ps
t_d	Delay time, CLKIN↑ to CLKOUT↓ (see Figure 7)	3	5	7	ns
t_{en}	Enable time, \overline{SHTDN} to phase lock		1		ms
t_{dis}	Disable time, \overline{SHTDN} to off state		400		ns
t_t	Transition time, output (10% to 90% t_r or t_f) (data only)		3		ns
t_t	Transition time, output (10% to 90% t_r or t_f) (clock only)		1.5		ns
t_w	Pulse duration, output clock		0.50 t_c		ns

(1) All typical values are at $V_{CC} = 3.3\text{ V}$, $T_A = 25^\circ\text{C}$.

(2) The parameter $t_{(RSKM)}$ is the timing margin available to allocate to the transmitter and interconnection skews and clock jitter. The value of this parameter at clock periods other than 15.38 ns can be calculated from $t_{RSKM} = tc/14 - 550\text{ ps}$.

(3) $|\text{Input clock jitter}|$ is the magnitude of the change in input clock period.

PARAMETER MEASUREMENT INFORMATION (continued)

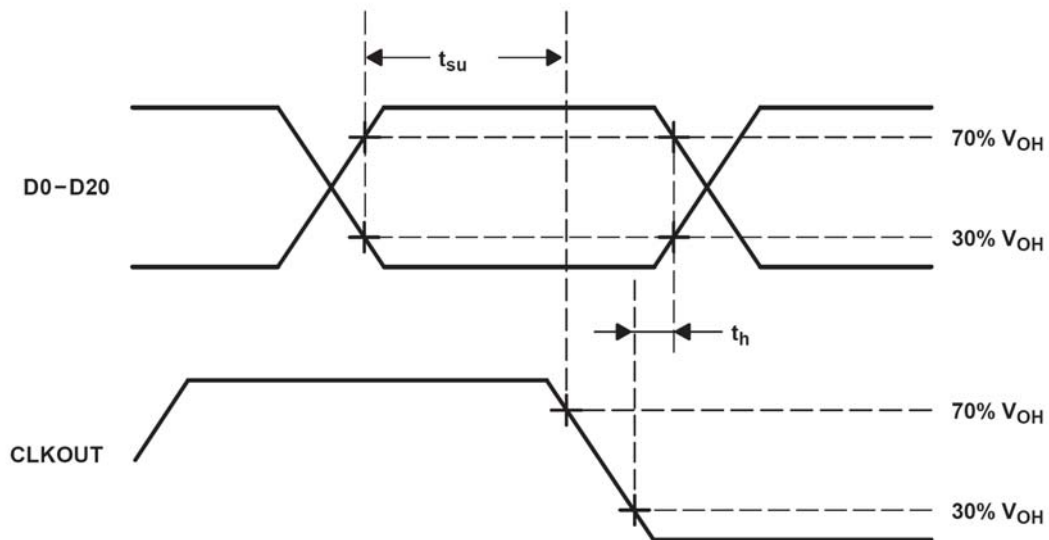

Figure 5. Setup and Hold Time Waveforms

PARAMETER MEASUREMENT INFORMATION (continued)

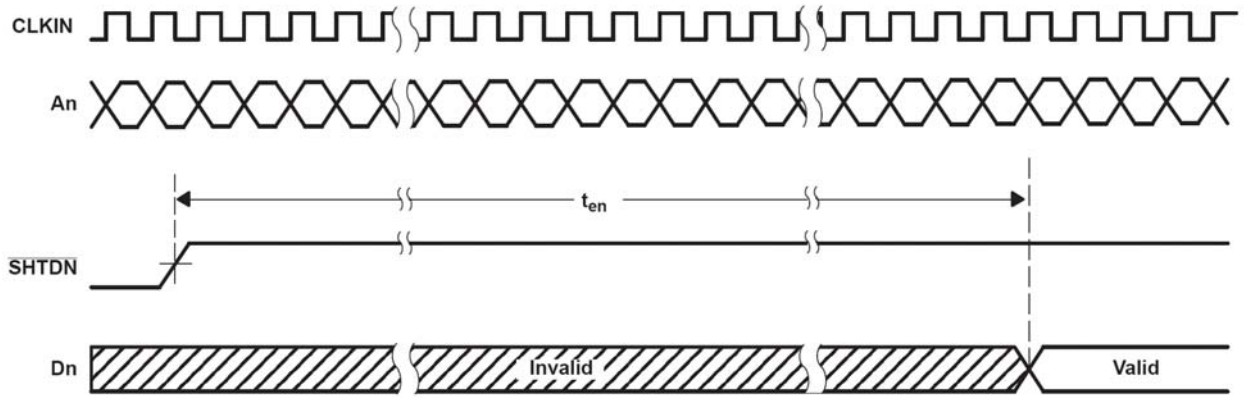

Figure 7. Enable Time Waveforms

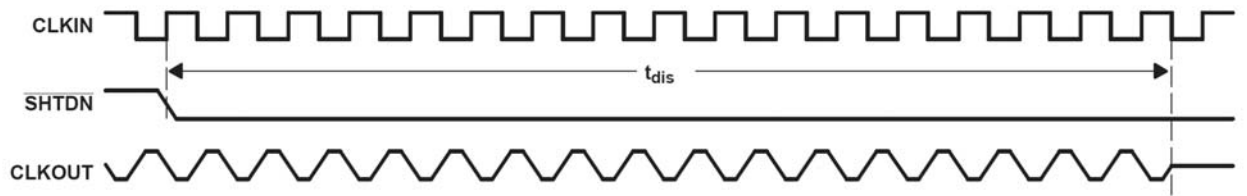

Figure 8. Disable Time Waveforms

8. OPTICAL CHARACTERISTICS

Item	Symbol	Condition	Min.	Typ.	Max.	Unit	Note	
Contrast ratio	CR	Point - 5 $\Theta = \Phi = 0^\circ$	200	250	--	--	(1)(2)(3)	
Luminance	Lw		--	500	-	cd/m ²	(1)(3)	
Luminance Uniformity	ΔL		70	75	-	%	(1)(3)	
Response Time (White – Black)	$T_r + T_f$		--	50	--	ms	(1)(3)(5)	
Viewing Angle	Vertical	Θ	CR \geq 10 Point – 5	80	100	-	Deg.	(1)(2)(4)
	Horizontal	Φ		120	140	-		
Color chromaticity	Red	Rx	Point - 5 $\Theta = \Phi = 0^\circ$	0.566	0.616	0.666	--	(1)(3)
		Ry		0.302	0.352	0.402		
	Green	Gx		0.308	0.358	0.408		
		Gy		0.518	0.568	0.618		
	Blue	Bx		0.096	0.146	0.196		
		By		0.086	0.136	0.186		
	White	Wx		0.296	0.346	0.396		
		Wy		0.328	0.378	0.428		

NOTE :

- (1) Measure conditions : 25°C ± 2°C , 60 ± 10%RH under 10Lux , in the dark room by BM-7TOPCON) , viewing 2° , VCC=3.3V , VDD=3.3V

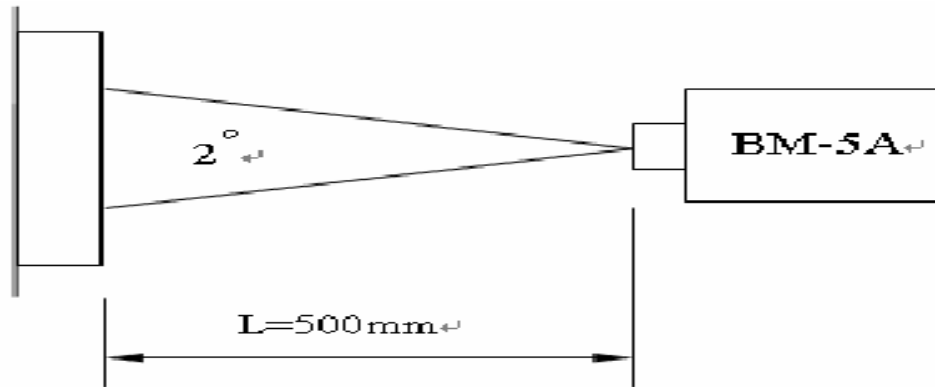

- (2) Definition of Contrast Ratio :

$$\text{Contrast Ratio (CR)} = (\text{White}) \text{ Luminance of ON} \div (\text{Black}) \text{ Luminance of OFF}$$

- (3) Definition of Luminance :

Definition of Luminance Uniformity

Measure white luminance on the point 5 as figure9-1

Measure white luminance on the point 1 ~ 9 as figure9-1

$$\Delta L = [L(\text{MIN}) / L(\text{MAX})] \times 100\%$$

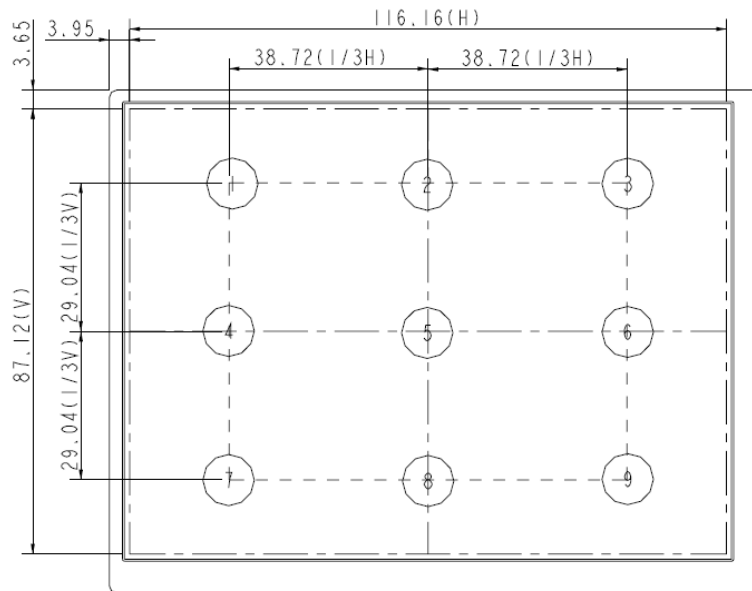

Fig9-1 Measuring point

(4) Definition of Viewing Angle(Θ , Φ), refer to Fig9-2 as below :

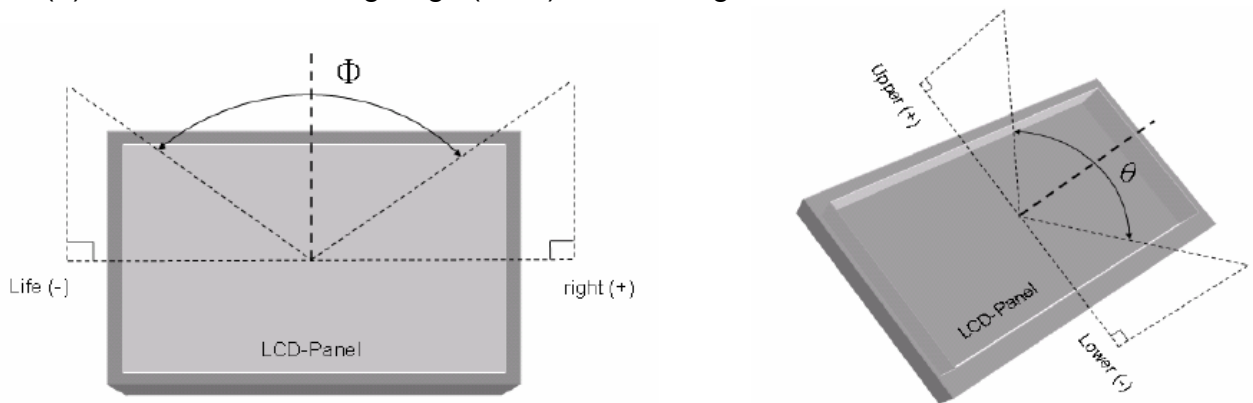

Fig9-2 Definition of Viewing Angle

(5) Definition of Response Time.(White – Black)

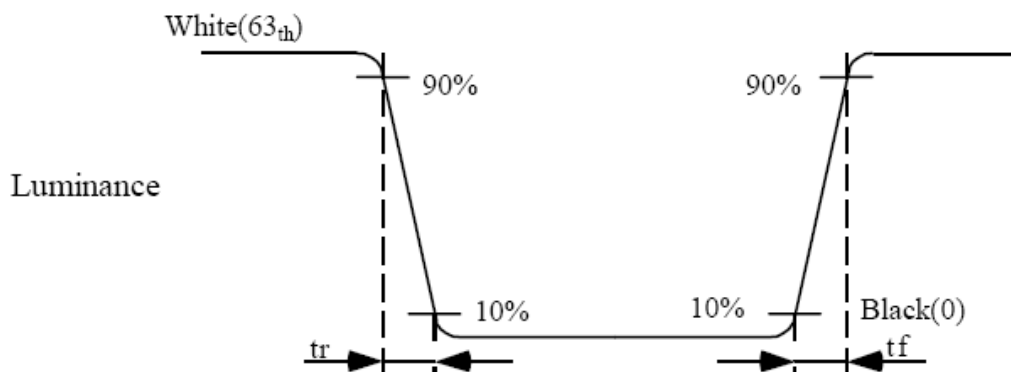

Fig9-3 Definition of Response Time(White-Black)

9. INCOMING INSPECTION STANDARD FOR TFT-LCD PANEL

DEFECT TYPE			LIMIT			Note		
VISUAL DEFECT	INTERNAL	SPOT	$\varphi < 0.15\text{mm}$		Ignore	Note1		
			$0.15\text{mm} \leq \varphi \leq 0.5\text{mm}$		$N \leq 4$			
			$0.5\text{mm} < \varphi$		$N=0$			
		FIBER	$0.03\text{mm} < W \leq 0.1\text{mm}, L \leq 5\text{mm}$		$N \leq 3$	Note1		
			$1.0\text{mm} < W, 1.5\text{mm} < L$		$N=0$			
		POLARIZER BUBBLE	$\varphi < 0.15\text{mm}$		Ignore	Note1		
			$0.15\text{mm} \leq \varphi \leq 0.5\text{mm}$		$N \leq 2$			
			$0.5\text{mm} < \varphi$		$N=0$			
		Mura	It' OK if mura is slight visible through 6%ND filter					
		ELECTRICAL DEFECT	BRIGHT DOT	A Grade			B Grade	
C Area	O Area			Total	C Area	O Area	Total	Note3
$N \leq 0$	$N \leq 2$			$N \leq 2$	$N \leq 2$	$N \leq 3$	$N \leq 5$	Note2
DARK DOT	$N \leq 2$		$N \leq 3$	$N \leq 3$	$N \leq 3$	$N \leq 5$	$N \leq 8$	
TOTAL DOT	$N \leq 4$			$N \leq 5$	$N \leq 6$	$N \leq 8$	Note2	
TWO ADJACENT DOT	$N \leq 0$		$N \leq 1$ pair	$N \leq 1$ pair	$N \leq 1$ pair	$N \leq 1$ pair	$N \leq 1$ pair	Note4
THREE OR MORE ADJACENT DOT	NOT ALLOWED							
LINE DEFECT	NOT ALLOWED							

(1) One pixel consists of 3 sub-pixels, including R,G, and B dot.(Sub-pixel = Dot)

(2) LITTLE BRIGHT DOT ACCEPTITABLE UNDER 6 % ND-Filter

[Note1] W : Width[mm], L : Length[mm], N : Number, φ : Average Diameter

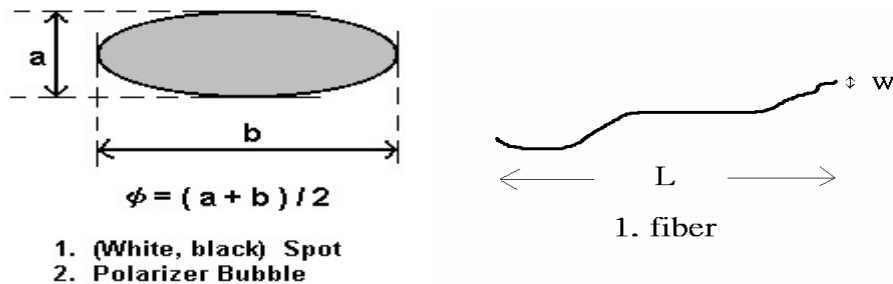

[Note2] Bright dot is defined through 6% transmission ND Filter as following.

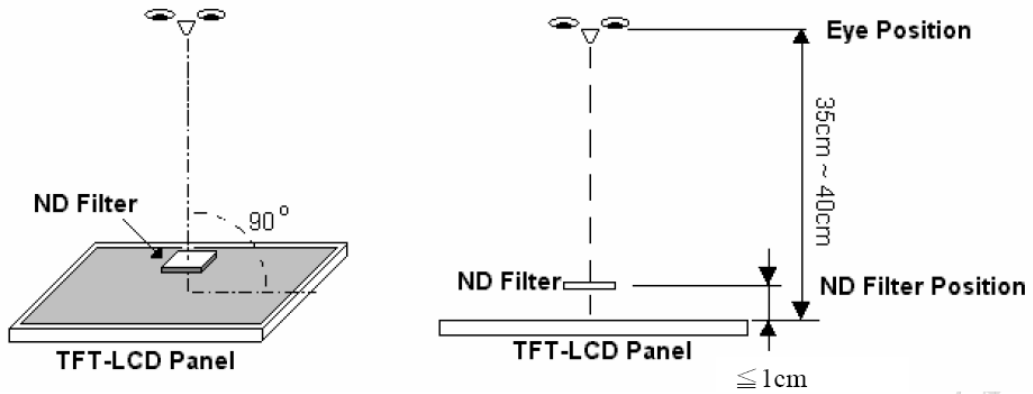

[Note3]

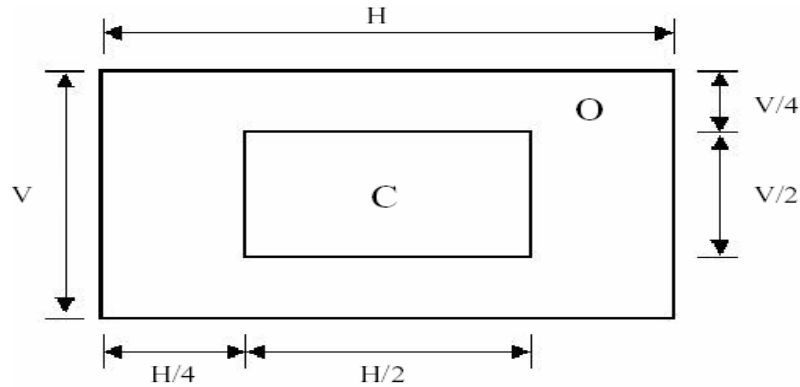

C Area: Center of display area

O Area: Outer of display area

[Note4]

Judge defect dot and adjacent dot as following. Allow below (as A, B, C and D status) adjacent defect dots, including bright and dark adjacent dot. And they will be counted 2 defect dots in total quantity.

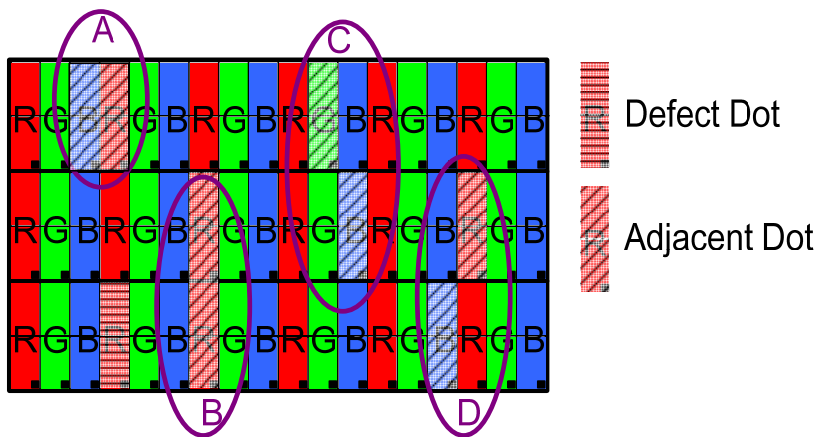

(1) The defects that are not defined above and considered to be problem shall be reviewed and discussed by both parties.

(2) Defects on the Black Matrix, out of Display area, are not considered as a defect or counted.

10. RELIABILITY TEST CONDITIONS

ITEM	CONDITIONS
HIGH TEMPERATURE OPERATION	70°C , 240Hrs
HIGH TEMPERATURE AND HIGH HUMIDITY OPERATION	60°C , 90%RH , 240Hrs
HIGH TEMPERATURE STORAGE	80°C , 240Hrs
LOW TEMPERATURE OPERATION	-20°C , 240Hrs
LOW TEMPERATURE STORAGE	-30°C , 240Hrs
THERMAL SHOCK	-30°C (0.5Hr) ~80°C (0.5Hr) 200Cycle

10.1 OTHERS

AMIPRE will provide one year warranty for all products and three months warrantee for all repairing products.

11. OUTLINE DIMENSION

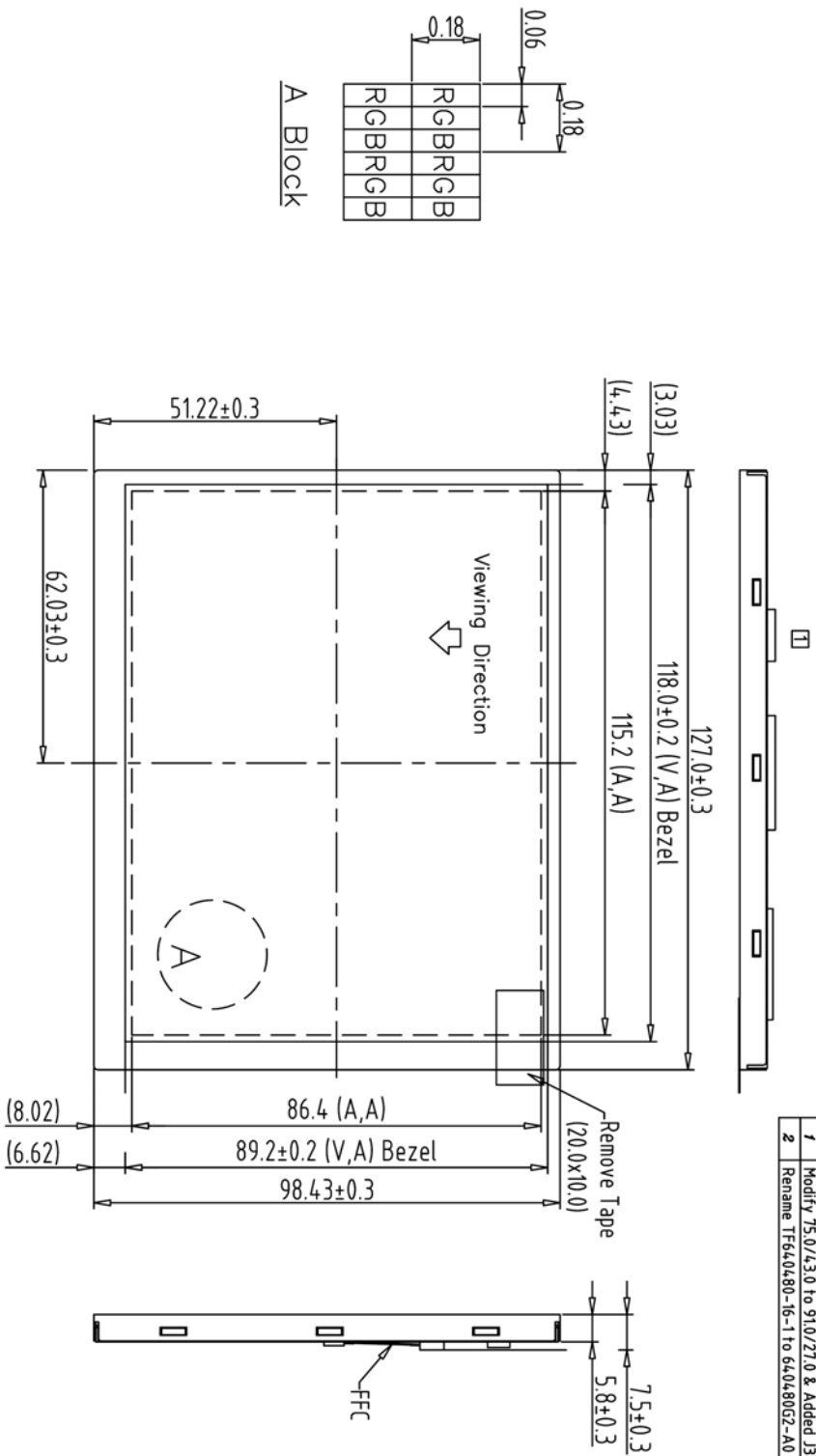

- Note:
1. Unless indicated, Tolerance Grade "B" is adopted.
 2. UV Glue For OLB Protection.
 3. LCD 640x480 (R.G:B) TFT LCD=>640480G2 5.7" VGA TFT LCD

REV	REVISION RECORD	DATE	NAME
0	NEW RELEASE	08-07-08	SNOW
1	Modify 75.0/43.0 to 91.0/27.0 & Added J3 Connector	08-04-08	SNOW
2	Rename TF640480-16-1 to 640480G2-A0	08-08-08	SNOW

NO.	ITEM	TOLERANCE GRADE(F)	A	B	DIM.	MM	DWN.	SNOW	DATE
1	TF640480-16-1								
2		~6	0.05	0.1					08-07-08
3		6~18	0.08	0.18	IE NO.		CHK.		DATE
4		18~50	0.1	0.25					
5		50~180	0.2	0.4	PARTS NO. LCM		APPD.		DATE
6		180~	0.3	0.5	640480G2-A0				

		晶采光電科技	
TITLE		640480G2-A0	
DWG. NO.		*080811MA	
SHEET		1 OF 1	

REV	REVISION RECORD	DATE	NAME
0	NEW RELEASE	08-07-08	SNOW
1	Modify J5, J4, J3, J2, J1 Connector	08-04-08	SNOW
2	Rename TF640480-16-1 to 640480G2-A0	08-09-08	SNOW

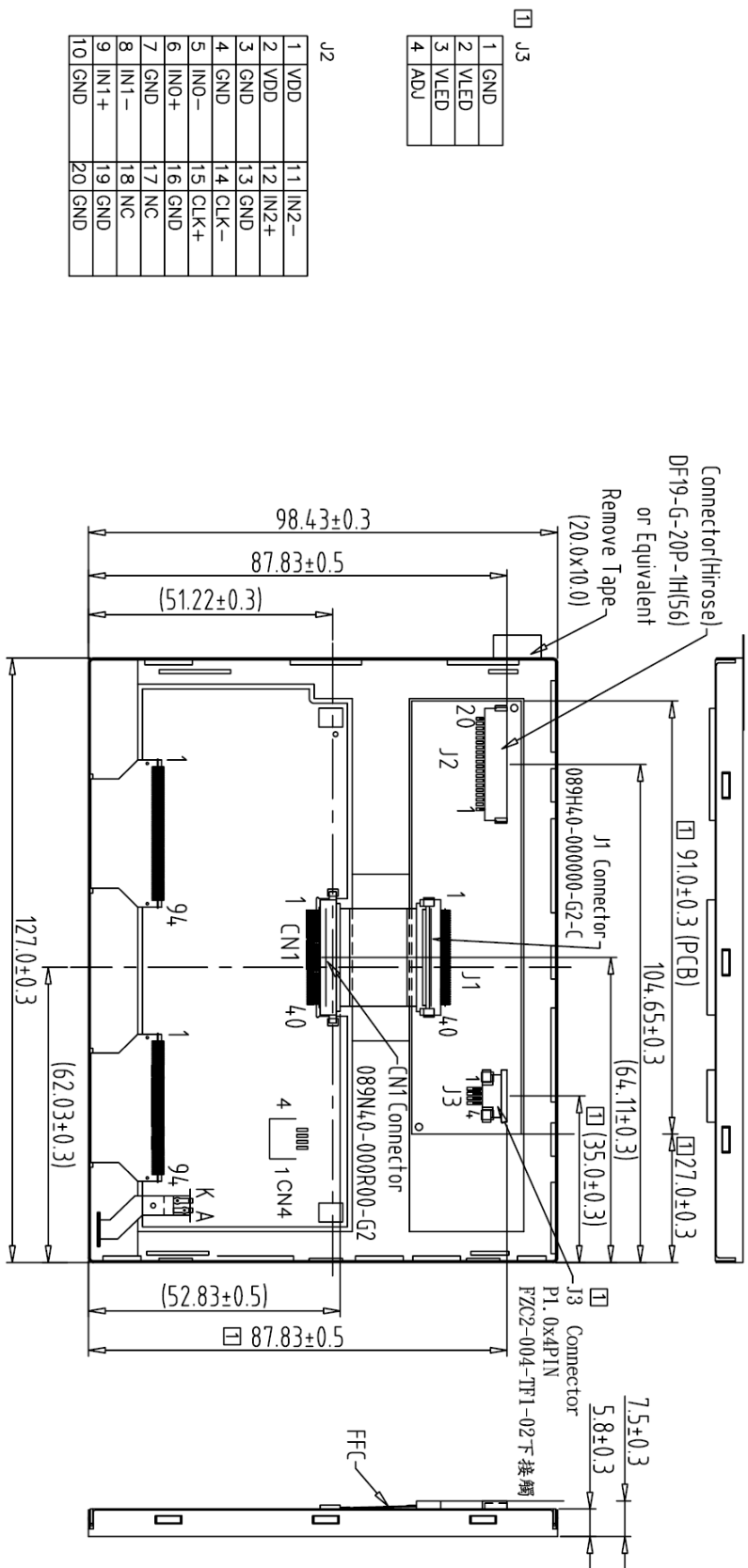

Back view

1	TF640480-16-1	7	7	TOLERANCE GRADE(±)	A	B	DIAM.	MM	DWN.	SNOW	DATE	TITLE
2		8		~6	0.05	0.1					08-07-08	AMPIRE 晶采光電科技 640480G2-A0 (5.7")
3		9		6~18	0.08	0.18	IE NO.		CHK.	DATE		
4		10		18~50	0.1	0.25						
5		11		50~180	0.2	0.4	PARTS NO. CM-1	APPD.	DATE			
6		12		180~	0.3	0.5	640480G2-A0					