

PC-HELPER

RS-232C 2ch Serial I/O Board with Isolation

COM-2P(PCI)H

RS-232C 4ch Serial I/O Board with Isolation

COM-4P(PCI)H

User's Guide

CONTEC CO.,LTD.

Check Your Package

Thank you for purchasing the CONTEC product.

The product consists of the items listed below.

Check, with the following list, that your package is complete. If you discover damaged or missing items, contact your retailer.

Product Configuration List

- Board(One of the following)
[COM-2P(PCI)H, or COM-4P(PCI)H] ...1
- First step guide ...1
- COM Setup Disk *1 (CD-ROM) ...1

*1 The CD-ROM contains the driver software and User's Guide (this guide)

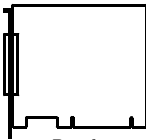

Board

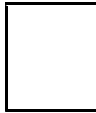

First step guide



CD-ROM

Copyright

Copyright 2013 CONTEC CO., LTD. ALL RIGHTS RESERVED

No part of this document may be copied or reproduced in any form by any means without prior written consent of CONTEC CO., LTD.

CONTEC CO., LTD. makes no commitment to update or keep current the information contained in this document. The information in this document is subject to change without notice.

All relevant issues have been considered in the preparation of this document. Should you notice an omission or any questionable item in this document, please feel free to notify CONTEC CO., LTD.

Regardless of the foregoing statement, CONTEC assumes no responsibility for any errors that may appear in this document nor for results obtained by the user as a result of using this product.

Trademarks

MS, Microsoft, Windows and Windows NT are trademarks of Microsoft Corporation. Other brand and product names are trademarks of their respective holder.

Table of Contents

Check Your Package.....	i
Copyright	ii
Trademarks	ii
Table of Contents	iii

1. BEFORE USING THE PRODUCT	1
------------------------------------	----------

About the Board.....	1
Features.....	1
Support Software	3
Cable & Connector (Option).....	4
Customer Support	5
Web Site.....	5
Limited Three-Years Warranty	5
How to Obtain Service	5
Liability	5
Safety Precautions	6
Safety Information.....	6
Handling Precautions.....	7
Environment	8
Inspection.....	8
Storage	8
Disposal	8

2. SETUP	9
-----------------	----------

What is Setup?.....	9
Using the Board under Windows Using the Standard COM Driver Software COM Setup Disk9	
Using the Board under Windows Using the Driver Library API-PAC(W32).....	9
Using the Board under Linux Using the Standard COM Driver Software COM Setup Disk..	10
Operating Systems Other than Windows or Linux	10
Step 1 Setting the Hardware.....	11
Parts of the Board and Factory Defaults	11
Setting the Board ID.....	12
Plugging the Board	13
Step 2 Installing the Hardware	14
Turning on the PC.....	14
Windows 8, 7	15
Windows Server 2008, Windows Vista	17
Windows Server 2003, Windows XP, Windows 2000	18
The check method of the completion of hardware installation.....	19
Step 3 Initializing the Software.....	20

For use under Windows 8, 7, Server 2008, Vista, XP, Server 2003, 2000.....	20
For use under Windows NT, Me, 98 or 95.....	22
Step 4 Checking Operations with the Diagnosis Program.....	23
What is the Diagnosis Program?	23
Check Method.....	23
Using the Diagnosis Program.....	24
Setup Troubleshooting.....	26
Symptoms and Actions	26
If your problem cannot be resolved.....	26

3. EXTERNAL CONNECTION	27
-------------------------------	-----------

In the case of COM-2P(PCI)H	28
Connecting directly to the port connector	28
In the case of COM-4P(PCI)H	29
Using the 9-pin D-SUB Connector Conversion Cables	29
Using the 25-pin D-SUB Connector Conversion Cables	30
Connecting it directly from the on-board connector.....	31
Types of Cable and Example Connections.....	32

4. FUNCTIONS	33
---------------------	-----------

Communication Function	33
Serial Data Transmission.....	33
RS-232C Control Lines	33
Send and Receive Data Buffers.....	33
Setting the Baud Rate	34
Other Functions	36
Channel Isolation/Bus Isolation	36
Surge Protection.....	36

5. ABOUT SOFTWARE	37
--------------------------	-----------

About Sample programs	37
Uninstalling the driver software.....	39
Windows XP, Server 2003, 2000	39
Windows 8, 7, Server 2008, Vista.....	39
Windows Me, 98, 95.....	39
Windows NT.....	40
CD-ROM Directory Structure	41

6. ABOUT HARDWARE	43
--------------------------	-----------

For detailed technical information	43
Hardware specification.....	43

1. Before Using the Product

This chapter provides information you should know before using the product.

About the Board

This product is an isolated PCI bus-supported board designed for extending RS-232C compatible serial communication functionality on your PC.

The < COM-2P(PCI)H > has two RS-232C communication ports.

The < COM-4P(PCI)H > has four RS-232C communication ports.

Higher noise-resistant models with isolation between a PC and bus line as well as a surge protection circuit for communication ports. With a 128byte built-in FIFO buffer for transmission and reception of each channel, the product supports a baud rate of up to 921,600bps.

It also comes with a Windows/Linux driver, which allows boards to be used as OS-standard COM ports.

This product supports CONTEC-defined driver library “API-PAC(W32)” that provide local routines.

Features

- Max. 921,600bps RS-232C Serial Communication

The < COM-2P(PCI)H > has two RS-232C-standard serial ports.

The < COM-4P(PCI)H > has four RS-232C-standard serial ports.

Baud rates from 2 to 921,600bps can be set.

When using the bundled “Standard COM Driver Software” and “Driver library API-PAC(W32)”, baud rates from 15 to 921,600bps can be set.

- Possibly used as Windows, Linux-standard COM ports, using the bundled driver library

Comes with a driver software that allows the products to be used under Windows / Linux in the same way as COM ports on the PC. Under Windows, the product supports the OS-standard Win32 API communication function as well as Visual Basic MSComm. Under Linux, OS-standard tty driver’s standard-function can be used. In addition, supplies a diagnostic program to confirm hardware operation and to perform a communication test with equipment.

- Isolation between channels and between PCs, surge protection for all signal lines

The channels are electrically isolated from each other and from the PC.

As isolation is provided between channels as well as isolation of the bus, this prevents electrical noise between channels as well as between the PC and external circuits. As surge protection is provided on all signal lines, you can safely use the boards in environments where you are concerned about surges causing incorrect operation or damage to the PC.

- Max. 16 boards can be installed as configured in the range COM1 - COM256.

Up to 16 boards can be mounted on a single PC.

COM1 - COM256 can be set using the device manager.

- Each channel is equipped with separate 128-byte FIFO buffers for transmit and receive.

Employed a buffer memory 128-byte dedicated to transmission and 128-byte for each channel.

These are FIFO format, useful for high speed communications and to reduce the load to the CPU when transmitting/receiving.

As the device manager can be used to enable/disable the use of FIFO and set the FIFO trigger size, you can build an optimum system according to your use.

- The boards use the same easy-to-use 9-pin D-SUB connectors as are used on a PC.
(For COM-2P(PCI)H only)

Using the most versatile general-purpose 9-pin D-SUB connector for RS-232C, the product allows you to use commercial cables which support the RS-232C standard.

- To suit your application, cables and connectors are available as optional.

COM-2P(PCI)H : Straight cables (1.8m), cross cables (1.8m) and 9-pin D-SUB connectors (male or female type) for your own cables are available as optional.

COM-4P(PCI)H : Straight cables (1.8m), cross cables (1.8m) and 37-pin D-SUB connectors (male or female type) for your own cables are available as optional.

- The control line for RS-232C can be controlled and monitored by software.

The control lines for RTS, CTS, DTR and DSR can be controlled and monitored using software.

- Driver library API-PAC(W32) is supported.

API-PAC(W32) is library software based on Win32 API routines (DLL), which provides local routines specific to CONTEC. You can create high-speed application software taking advantage of the CONTEC hardware using various programming languages that support Win32 API functions, such as Visual Basic and Visual C++.

Support Software

You should use CONTEC support software according to your purpose and development environment.

Standard COM Driver Software **COM Setup Disk** (Bundled)

The purpose of this software is to allow the CONTEC serial communication boards to be used under Windows or Linux in the same way as the standard COM ports on the PC. By installing additional boards, you can use COM ports in the range COM1 - COM256.

The boards can be used for all types of serial communications such as for remote access service (RAS) and uninterruptible power supply (UPS) applications.

Under Windows, the serial ports can be accessed using the standard Win32 API communication routines (CreateFile(), WriteFile(), ReadFile(), and SetCommState(), etc.) The serial ports are also compatible with the Visual Basic communication control (MSComm). Supports the communication class of .NET Framework 2.0 (SerialPort class).

Under Linux, the serial ports are compatible with the operating system's standard tty driver. The standard routines including open(), close(), read(), write() are supported.

< Operating environment >

OS Windows 8, 7, Vista, XP, NT, Me, 98, Linux etc..

You can download the updated version from the CONTEC's Web site (<http://www.contec.com/comdrv/>). For more details on the supported OS, applicable language and new information, please visit the CONTEC's Web site.



CAUTION

The maximum number of COM ports able to be used depends on the configuration of your OS.

Driver library **API-PAC(W32)** (Available for downloading (free of charge) from the CONTEC web site.)

API-PAC(W32) is the library software that provides the commands for CONTEC hardware products in the form of Windows standard Win32 API functions (DLL). It makes it easy to create high-speed application software taking advantage of the CONTEC hardware using various programming languages that support Win32 API functions, such as Visual Basic and Visual C/C++.

For more details and how to download API-PAC(W32), visit <http://www.contec.co.jp/apipac/>.

< Operating environment >

OS Windows 7, Vista, XP, Server 2003 etc.

Adaptation language Visual Basic, Visual C++, Visual C#, Delphi, C++ Builder



CAUTION

This library provides local routines that are specific to CONTEC (SioOpen(), SioWrite(), SioRead(), SioStatus(), etc.). These are not compatible with the standard Win32 API communication routines (CreateFile() and WriteFile(), etc.).

Cable & Connector (Option)

RS-232C Straight Cable with D-SUB9P (1.8m)	:	RSS-9M/F
RS-232C Cross Cable with D-SUB9P (1.8m)	:	RSC-9F
RS-232C Straight Cable with D-SUB25P (1.8m)	:	RSS-25M/9F
RS-232C Cross Cable with D-SUB25P (1.8m)	:	RSC-25F
RS-232C Connection Conversion Straight Cable (25M→9F, 1.8m)	:	RSS-25M/9F
RS-232C Connection Conversion Straight Cable (25F→9M, 1.8m)	:	RSS-25F/9M
RS-232C Connection Conversion Cross Cable (25F→9F, 1.8m)	:	RSC-25F/9F
Connection Conversion Cable (37M→9M x 4, 250mm)	:	PCE37/9PS
Connection Conversion Cable (37M→25M x 4, 250mm)	:	PCE37/25PS
D-SUB9P Male Connector Set (5 Pieces)	:	CN5-D9M
D-SUB9P Female Connector Set (5 Pieces)	:	CN5-D9F
D-SUB25P Male Connector Set (5 Pieces)	:	CN5-D25M
D-SUB25P Female Connector Set (5 Pieces)	:	CN5-D25F
D-SUB37P Male Connector Set (5 Pieces)	:	CN5-D37M

* Check the CONTEC's Web site for more information on these options.

Customer Support

CONTEC provides the following support services for you to use CONTEC products more efficiently and comfortably.

Web Site

Japanese <http://www.contec.co.jp/>
English <http://www.contec.com/>
Chinese <http://www.contec.com.cn/>

Latest product information

CONTEC provides up-to-date information on products.

CONTEC also provides product manuals and various technical documents in the PDF.

Free download

You can download updated driver software and differential files as well as sample programs available in several languages.

Note! For product information

Contact your retailer if you have any technical question about a CONTEC product or need its price, delivery time, or estimate information.

Limited Three-Years Warranty

CONTEC Interface boards are warranted by CONTEC CO., LTD. to be free from defects in material and workmanship for up to three years from the date of purchase by the original purchaser.

Repair will be free of charge only when this device is returned freight prepaid with a copy of the original invoice and a Return Merchandise Authorization to the distributor or the CONTEC group office, from which it was purchased.

This warranty is not applicable for scratches or normal wear, but only for the electronic circuitry and original boards. The warranty is not applicable if the device has been tampered with or damaged through abuse, mistreatment, neglect, or unreasonable use, or if the original invoice is not included, in which case repairs will be considered beyond the warranty policy.

How to Obtain Service

For replacement or repair, return the device freight prepaid, with a copy of the original invoice. Please obtain a Return Merchandise Authorization Number (RMA) from the CONTEC group office where you purchased before returning any product.

* No product will be accepted by CONTEC group without the RMA number.

Liability

The obligation of the warrantor is solely to repair or replace the product. In no event will the warrantor be liable for any incidental or consequential damages due to such defect or consequences that arise from inexperienced usage, misuse, or malfunction of this device.

Safety Precautions

Understand the following definitions and precautions to use the product safely.

Safety Information

This document provides safety information using the following symbols to prevent accidents resulting in injury or death and the destruction of equipment and resources. Understand the meanings of these labels to operate the equipment safely.

⚠ DANGER	DANGER indicates an imminently hazardous situation which, if not avoided, will result in death or serious injury.
⚠ WARNING	WARNING indicates a potentially hazardous situation which, if not avoided, could result in death or serious injury.
⚠ CAUTION	CAUTION indicates a potentially hazardous situation which, if not avoided, may result in minor or moderate injury or in property damage.

Handling Precautions

DANGER

Do not use the product where it is exposed to flammable or corrosive gas. Doing so may result in an explosion, fire, electric shock, or failure.

CAUTION

- There are switches or jumpers on the board that need to be set in advance. Be sure to check these before installing the board.
 - Only set the switches and jumpers on the board to the specified settings. Otherwise, the board may malfunction, overheat, or cause a failure.
 - Do not strike or bend the board. Doing so could damage the board. Otherwise, the board may malfunction, overheat, cause a failure or breakage.
 - Do not touch the board's metal plated terminals (edge connector) with your hands. Otherwise, the board may malfunction, overheat, or cause a failure. If the terminals are touched by someone's hands, clean the terminals with industrial alcohol.
 - Do not install or remove the board to or from the slot while the computer's power is turned on. Otherwise, the board may malfunction, overheat, or cause a failure. Doing so could cause trouble. Be sure that the personal computer or the I/O expansion unit power is turned off.
 - Make sure that your PC or expansion unit can supply ample power to all the boards installed. Insufficiently energized boards could malfunction, overheat, or cause a failure.
 - The specifications of this product are subject to change without notice for enhancement and quality improvement. Even when using the product continuously, be sure to read the manual and understand the contents.
 - Do not modify the product. CONTEC will bear no responsibility for any problems, etc., resulting from modifying this product.
 - Regardless of the foregoing statements, CONTEC is not liable for any damages whatsoever (including damages for loss of business profits) arising out of the use or inability to use this CONTEC product or the information contained herein.
-

Environment

Use this product in the following environment. If used in an unauthorized environment, the board may overheat, malfunction, or cause a failure.

Operating temperature

0 - 50°C

Humidity

10 - 90%RH (No condensation)

Corrosive gases

None

Floating dust particles

Not to be excessive

Inspection

Inspect the product periodically as follows to use it safely.

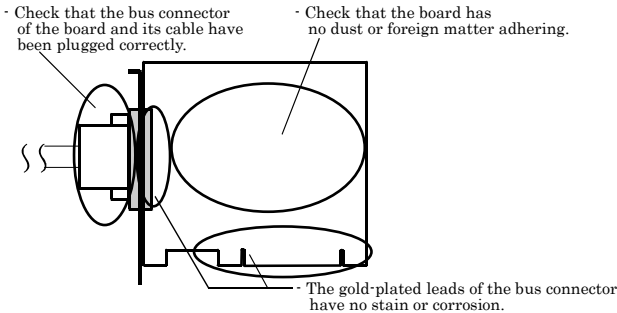

Storage

When storing this product, keep it in its original packing form.

- (1) Put the board in the storage bag.
- (2) Wrap it in the packing material, then put it in the box.
- (3) Store the package at room temperature at a place free from direct sunlight, moisture, shock, vibration, magnetism, and static electricity.

Disposal

When disposing of the product, follow the disposal procedures stipulated under the relevant laws and municipal ordinances.

2. Setup

This chapter explains how to set up the board.

What is Setup?

Setup means a series of steps to take before the product can be used.

Different steps are required for software and hardware

The setup procedure varies with the OS and applications used.

Using the Board under Windows

Using the Standard COM Driver Software COM Setup Disk

This section describes the setup procedure to be performed before you can start developing application programs for the board using the bundled CD-ROM “Standard COM Driver Software - COM Setup Disk”.

Taking the following steps sets up the software and hardware. You can use the diagnosis program later to check whether the software and hardware function normally.

Step 1 Setting the Hardware

Step 2 Installing the Hardware

Step 3 Initializing the Software

On the CD-ROM, refer to the \PCI\Readmee.txt file and the installation instructions files for each OS located in the \PCI\InstDoc.

If Setup fails to be performed normally, see the “Setup Troubleshooting” section at the end of this chapter.

Using the Board under Windows

Using the Driver Library API-PAC(W32)

Refer to the API-PAC(W32) "Hardware Installation Procedure (HWINST.CHM)" help file for the procedure to follow when using API-SIO in the "Driver Library API-PAC(W32)".

If using API-SIO from API-PAC(W32), install from API-PAC(W32) instead of from the supplied CD-ROM.

See also the following parts of this manual as required.

This chapter Step 1 Setting the Hardware

Using the Board under Linux

Using the Standard COM Driver Software COM Setup Disk

You can perform application program development using the "Standard COM Driver Software - COM Setup Disk" in the supplied CD-ROM. The procedure for using the software is described in the \Linux\Readmee.htm file.

See also the following parts of this manual as required.

This chapter Step 1 Setting the Hardware

Operating Systems Other than Windows or Linux

Refer to the following if using on an OS other than Windows or Linux.

This chapter Step 1 Setting the Hardware

Chapter 4 Functions

Chapter 6 About Hardware

Step 1 Setting the Hardware

This section describes how to set the board and plug it on your PC.

The board has some switches and jumper to be preset.

Check the on-board switches and jumpers before plugging the board into an expansion slot.

The board can be set up even with the factory defaults untouched. You can change board settings later.

Parts of the Board and Factory Defaults

Figure 2.1 - 2.2 shows the names of major parts on the board.

Note that the switch setting shown below is the factory default.

COM-2P(PCI)H

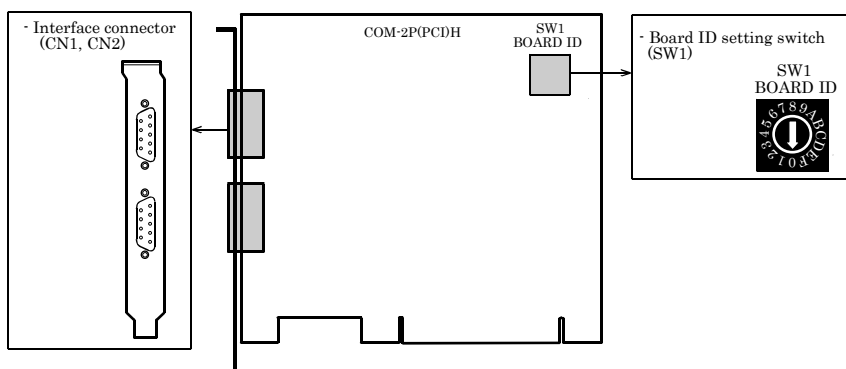

Figure 2.1. Component Locations < COM-2P(PCI)H >

COM-4P(PCI)H

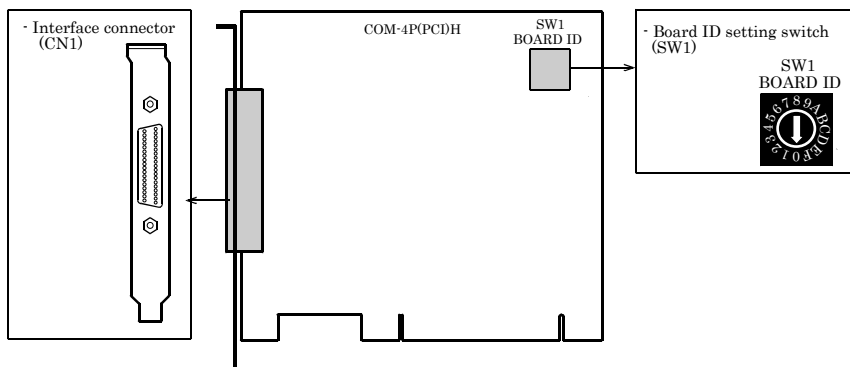

Figure 2.2. Component Locations < COM-4P(PCI)H >

Setting the Board ID

If you install two or more boards on one personal computer, assign a different ID value to each of the boards to distinguish them.

The board IDs can be set from 0 - Fh to identify up to sixteen boards.

If only one board is used, the original factory setting (Board ID = 0) should be used.

Setting Procedure

To set the board ID, use the rotary switch on the board. Turn the SW1 knob to set the board ID as shown below.

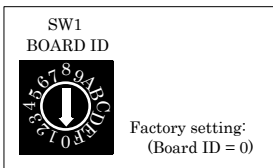

Figure 2.3. Board ID Settings (SW1)

Plugging the Board

- (1) Before plugging the board, shut down the system, unplug the power cord of your PC.
- (2) Remove the cover from the PC so that the board can be mounted.
- (3) Plug the board into an expansion slot.
- (4) Attach the board bracket to the PC with a screw.
- (5) Put the cover back into place.



Applicable PCI bus slots

PCI bus slots used in PCs have keys to prevent 5V and 3.3V PCI bus boards from being accidentally plugged into wrong bus slots. This board can be plugged into both of the 5V and 3.3V PCI bus slots.

<PCI bus slot>

5-V PCI bus slot

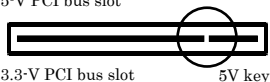

3.3-V PCI bus slot

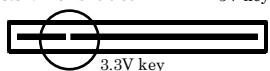

<PCI bus board>

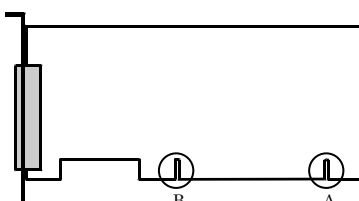

A : Slit for 5-V PCI bus slot
B : Slit for 3.3-V PCI bus slot

⚠ CAUTION

- Do not touch the board's metal plated terminals (edge connector) with your hands. Otherwise, the board may malfunction, overheat, or cause a failure. If the terminals are touched by someone's hands, clean the terminals with industrial alcohol.
- Do not install or remove the board to or from the slot while the computer's power is turned on. Otherwise, the board may malfunction, overheat, or cause a failure. Doing so could cause trouble. Be sure that the personal computer or the I/O expansion unit power is turned off.
- Make sure that your PC or expansion unit can supply ample power to all the boards installed. Insufficiently energized boards could malfunction, overheat, or cause a failure.
- Power supply from the PCI bus slot at +5V is required.

Step 2 Installing the Hardware

For using an expansion board under Windows, you have to let the OS detect the I/O addresses and IRQ to be used by the board. The process is referred to as installing the hardware.

In the case of using two or more boards, make sure you install one by one with the Found New Hardware Wizard.

Turning on the PC

Turn on the power to your PC.

CAUTION

- Refer to the API-PAC(W32) "Hardware Installation Procedure (HWINST.CHM)" help file for the procedure to follow when using API-SIO in the "Driver Library API-PAC(W32)".
If using API-SIO from API-PAC(W32), install from API-PAC(W32) instead of from the supplied CD-ROM. If you install from the CD-ROM by mistake, uninstall API-SIO as described in "Uninstalling the Driver Software" in "Chapter 5 Software".
 - The board cannot be properly installed unless the resources (I/O addresses and interrupt level) for the board can be allocated. Before attempting to install the board, first determine what PC resources are free to use.
 - The resources used by each board do not depend on the location of the PCI bus slot or the board itself. If you remove two or more boards that have already been installed and then remount one of them on the computer, it is unknown that which one of the sets of resources previously assigned to the two boards is assigned to the remounted board. In this case, you must check the resource settings.
-

Windows 8, 7

- (1) Select “Devices and Printers” from the Start menu*1 and select the PC to which this board is attached. Click on the device “PCI Serial Port” (or “PCI Simple Communication Controller”) and open its properties by clicking the [Properties] button.

*1 Please search for “Devices and Printers” case of Windows 8

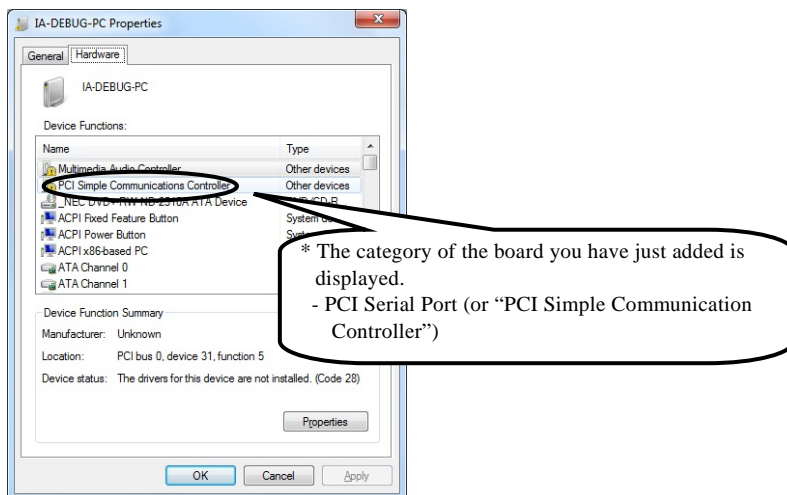

- (2) In the “PCI Serial `Port Properties (or “PCI Simple Communications Controller Properties”)” page, click the [Change settings] button and edit the settings as an Administrator. Then click the [Update Driver...] button.

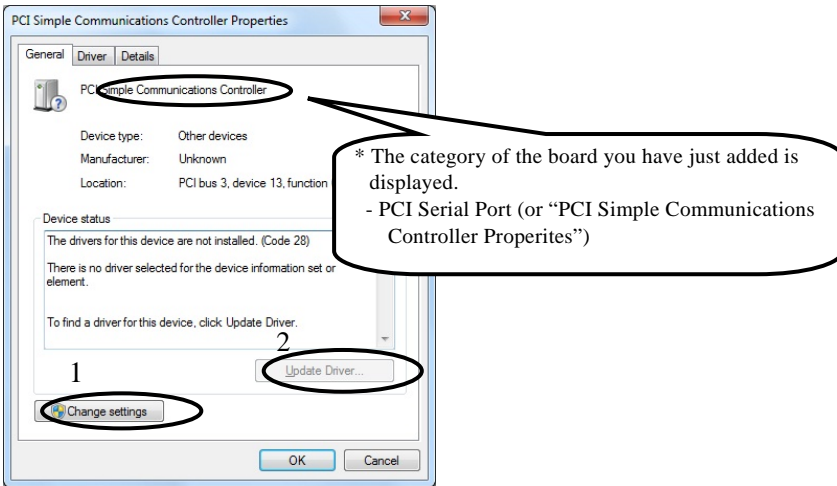

- (3) The Driver Installation Wizard is open. Click “Browse my computer for driver software”.

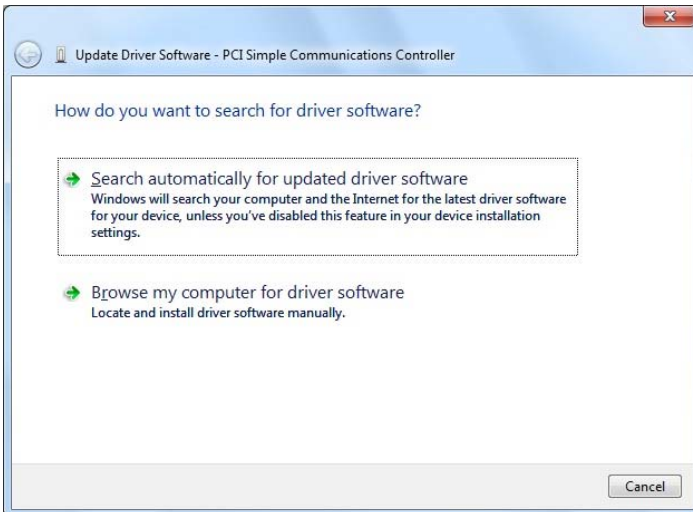

- (4) Specify that folder on the CD-ROM which contains the setup information (INF) file to register the board.
- Source folder \PCI \ComDrv

You have now finished installing the hardware.

Windows Server 2008, Windows Vista

- (1) “Found New Hardware” wizard is open. Click “Locate and install driver software”.

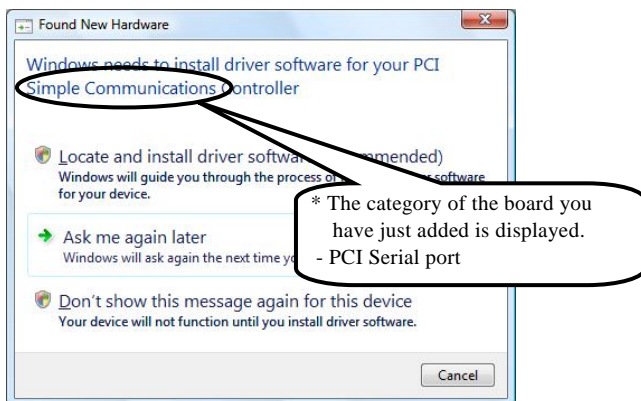

- (2) When the “Found New Hardware” window is displayed, insert the accompanying CD-ROM “COM Setup Disk” into the CD-ROM drive. After a while, the device installation process begins.

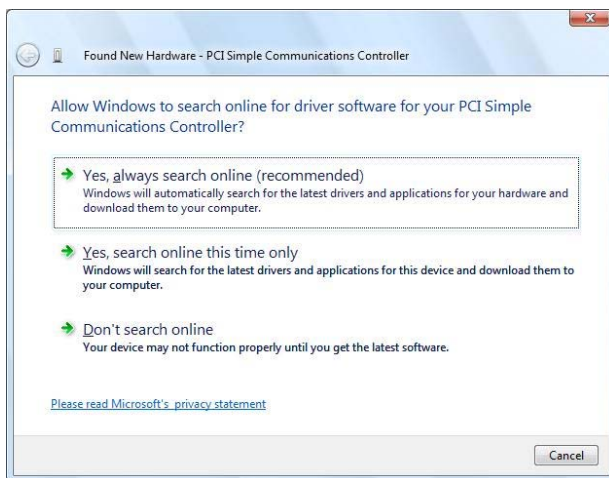

You have now finished installing the hardware.

Windows Server 2003, Windows XP, Windows 2000

- (1) The “Found New Hardware Wizard” will be started.
Select “Install from a list or specific location[Advanced]”, then click on the [Next] button.
**If you are using Windows NT 4.0, the “Found New Hardware Wizard” is not started.
Go to Step 4 “Initializing the Software”.**



- (2) Specify that folder on the CD-ROM which contains the setup information (INF) file to register the board.
- Source folder \PCI\ComDrv



⚠ CAUTION

In Windows XP, the Hardware Wizard displays the following alert dialog box when you have located the INF file. This dialog box appears, only indicating that the relevant driver has not passed Windows Logo testing, and it can be ignored without developing any problem with the operation of the board.

In this case, click on the [Continue Anyway] button.

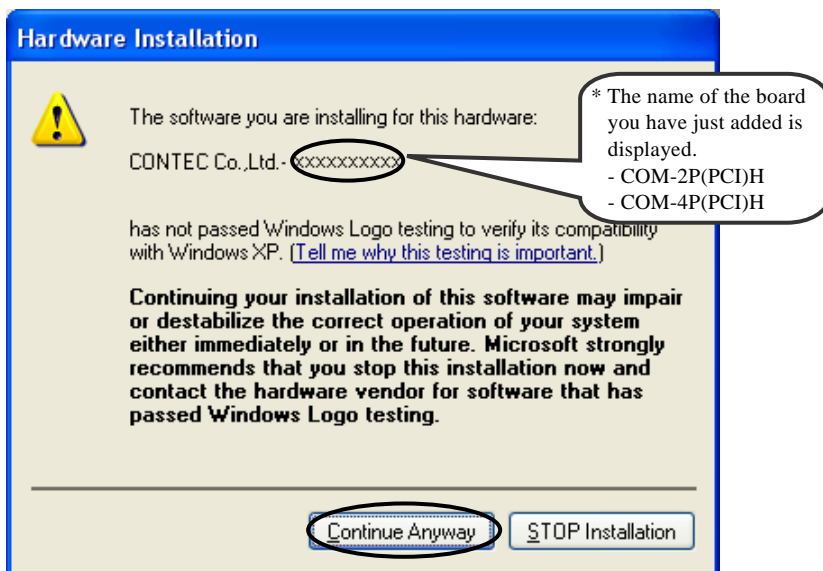

- (3) Installation of the "Communication Port" starts next. If prompted for a file by the OS, specify the location of the setup information (INF) file, as described above.

You have now finished installing the hardware.

The check method of the completion of hardware installation

- (1) Select "System" from "Control Panel" and open [Device Manager].
- (2) Check that the names of the boards you are using are registered correctly in the [Multifunction adapters] folder.
- (3) Similarly, confirm that the COM ports have been added in the [Ports] folder.

Step 3 Initializing the Software

This assigns COM ports to the serial ports on the board. You can also change a previously assigned COM port number to a different number.

For use under Windows 8, 7, Server 2008, Vista, XP, Server 2003, 2000

On Windows 8, 7, Server 2008, Vista, XP, Server 2003 and 2000, the COM ports are already assigned by the hardware installation step. Run Device Manager as described below if you wish to view or modify the COM port settings.

Start Device Manager

- (1) Select "System" from "Control Panel" and start [Device Manager].

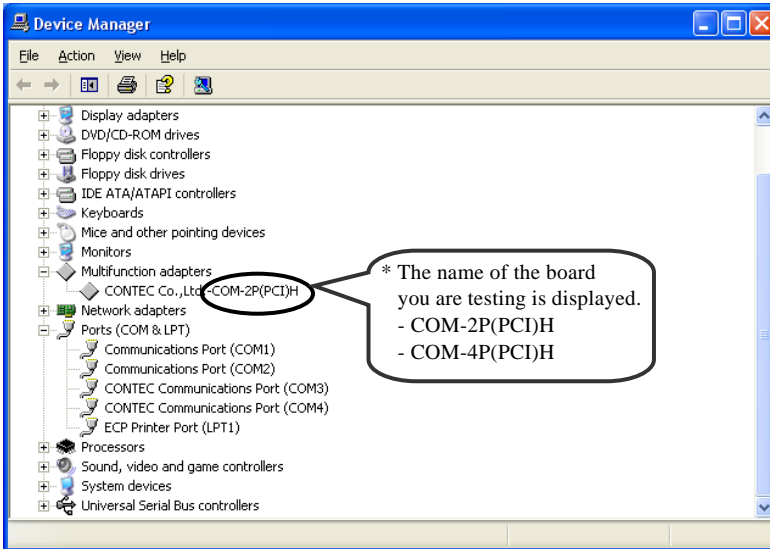

- (2) Check that the new COM ports are displayed in the [Ports] folder.

Updating the Settings

- (1) If you wish to change a port number, open the properties page for the port and click the [Advanced...] button under [Port Settings].
- (2) Use the [COM Port Number] combo box to modify the COM port number.
- (3) Clicking the [Advanced...] button opens the “Advanced Settings for COMn” window.

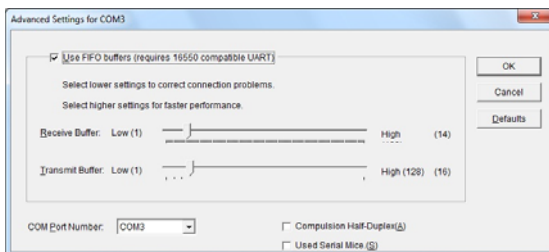

- Use the “COM Port Number” combo box to select the COM port number.
- By selecting the “Compulsion Half-Duplex”, the software settings are forced to switch from full-duplex communication to half-duplex.
- By selecting the “Used Serial Mice”, support for the serial mouse devices is enabled.

You have now finished installing the initial setting of Software.

For use under Windows NT, Me, 98 or 95

Installing the setup information (INF) file.

This procedure only applies to Windows NT.

- (1) Right click on the \PCI\ComDrv\COMNT_PL.INF file in the CD-ROM, then left click on the [Install] button.

Invoking API-TOOL Configuration

- (1) Execute C:\CONTEC\Config.exe.

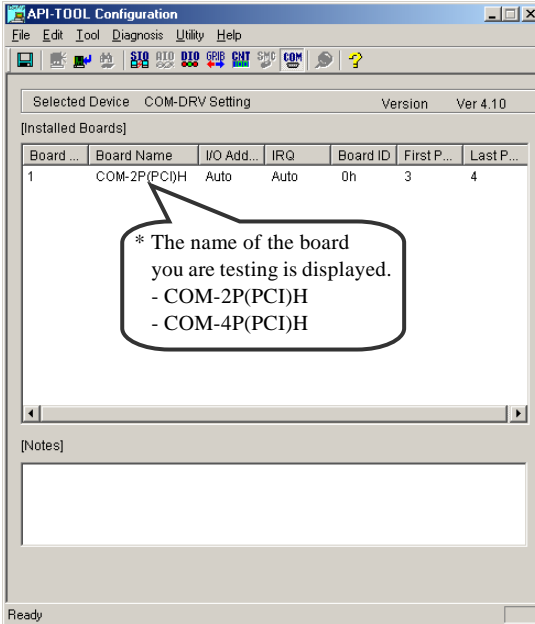

- (2) Check that [COM-DRV Setting] appears on the screen.
If a different driver name appears, execute [Tools] - [COM-DRV].
- (3) Windows NT, execute [Edit] - [Add Board] to register the board type, COM port number and related settings. Alternatively, double click on a board type name that is already displayed on the screen and modify the COM port number and related settings.
On other than Windows NT, double click on the board type name that is already displayed on the screen and modify the COM port number and related settings.

Updating the Settings

- (1) Select "Save settings to registry..." from the "File" menu.
- (2) After rebooting, the registered COM ports are now able to be used as standard COM ports.

You have now finished installing the initial setting of Software.

Step 4 Checking Operations with the Diagnosis Program

Use the diagnosis program to check that the board and driver software work normally, thereby you can confirm that they have been set up correctly.

What is the Diagnosis Program?

These programs perform some simple checks on the board operation. Two programs are provided.

Terminal program (CTstCom.exe)

Data entered from the keyboard is sent directly from the port. The function of the program is equivalent to the Hyper Terminal program provided with Windows.

Serial Communications Diagnostic Program (CommChk.exe)

Performs actual communications and indicates whether the results are correct or not (error).

The following describes the procedure for testing using the serial communications diagnostic program (CommChk.exe).

Check Method

Obtain an RS-232C cross cable. If you do not have a cross cable, you can use a switch on the board to perform testing of a single COM port using loopback communications. See the figure below for the switch settings.

Switch setting for using a cross cable

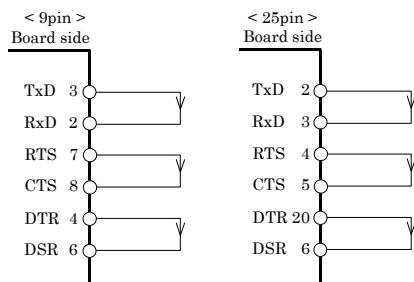

Using the Diagnosis Program

Starting the Diagnosis Program

Run\Utility\CommChk\CommChk.exe from the supplied CD-ROM.

Communication Settings

COM Setup: Specify the number of the COM port you wish to test.

If connecting two COM ports via a cross cable, specify the respective COM ports in [Device1] and [Device2].

When performing loopback communications on a single COM port, set the same port number in both [Device 1] and [Device 2].

Communication Settings: Specify the [Bits / Second], [Data bits] and other settings you wish to use.

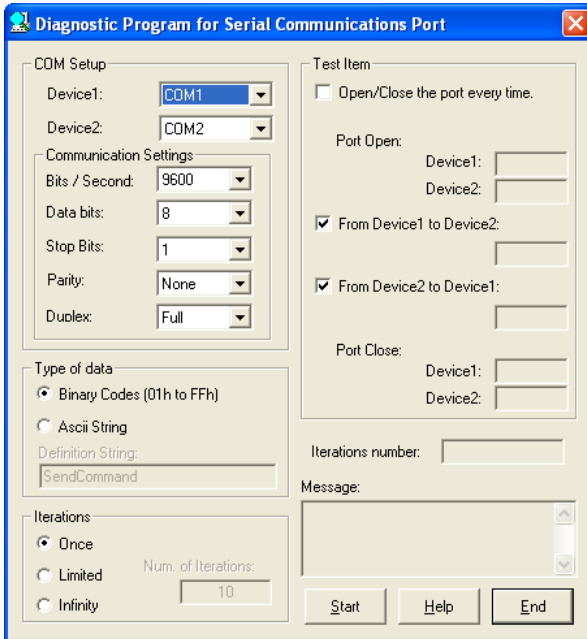

Start test

Click the [Start] button to start the test using the specified conditions.

View test result

The test result is displayed in the [Message] window.

A successful completion message appears if the test completed OK.

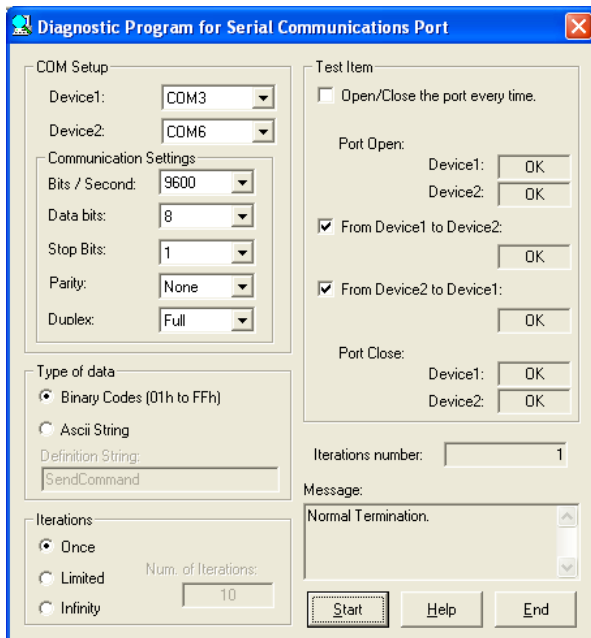

Setup Troubleshooting

Symptoms and Actions

The board cannot be initialized. [Windows NT 4.0]

The driver may not yet be activated.

When using the board under an OS not compliant with Plug and Play, such as Windows NT 4.0, make sure that the [PnP OS] BIOS option has been set to [NO], [disable], or [Do not use]. For details on BIOS settings, refer to the user's guide for your PC.

Incorrect driver software was installed by mistake [Windows 8, 7, Server 2008, Vista, XP, Server 2003, 2000]

The API-SIO software from the "Driver Library API-PAC(W32)" cannot be installed in the PC at the same time as the "Standard COM Driver Software COM Setup Disk" from the supplied CD-ROM.

The COM Setup Disk and the API-SIO software from API-PAC(W32) are intended for different purposes. Please only use the software that is applicable for your intended use.

If the incorrect software is installed by mistake, please uninstall the incorrect software then install the correct software.

If your problem cannot be resolved

Contact your retailer.

3. External Connection

This chapter describes the interface connectors on the board.

Check the information available here when connecting an external device.

In addition to connecting directly to the connector on the board, you can also connect external devices via a distribution cable or distribution unit.

- Connecting directly to the port connector.
- Using a distribution cable [COM-4P(PCI)H]

In the case of COM-2P(PCI)H

Connecting directly to the port connector

When connecting directly from the connector on the board to the external device, use the appropriate cable which can be purchased separately. If making your own cable, use a CN5-D9F or similar connector which can be purchased separately.

Pin Assignment

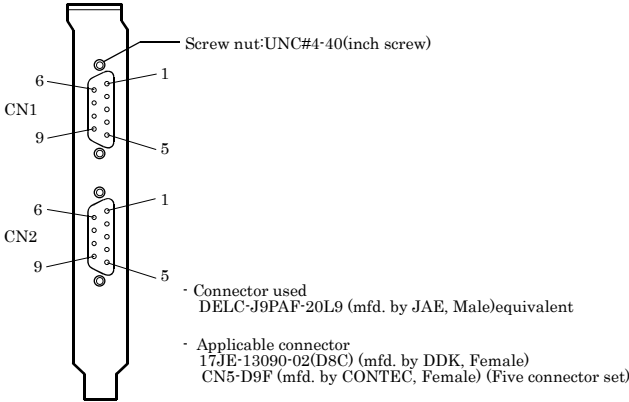

Figure 3.1. Interface Connector < COM-2P(PCI)H >

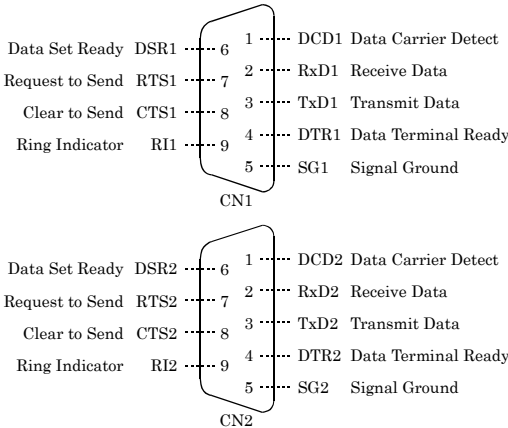

Figure 3.2. Pin Assignments of Interface Connector < COM-2P(PCI)H >

Cable (Option)

- RS-232C Straight Cable with D-SUB9P (1.8m) : RSS-9M/F
- RS-232C Cross Cable with D-SUB9P (1.8m) : RSC-9F

In the case of COM-4P(PCI)H

When using a COM-4P(PCI)H, an alternative to connecting an external device directly to the connector on the board is to use a connection conversion cable.

Using the 9-pin D-SUB Connector Conversion Cables

Use a PCE37/9PS connection conversion cable (purchased separately) to connect to external devices after dividing into four 9-pin D-SUB male connector channels.

Use cable suitable for use with 9-pin D-SUB connectors (purchase separately) with the four divided connectors.

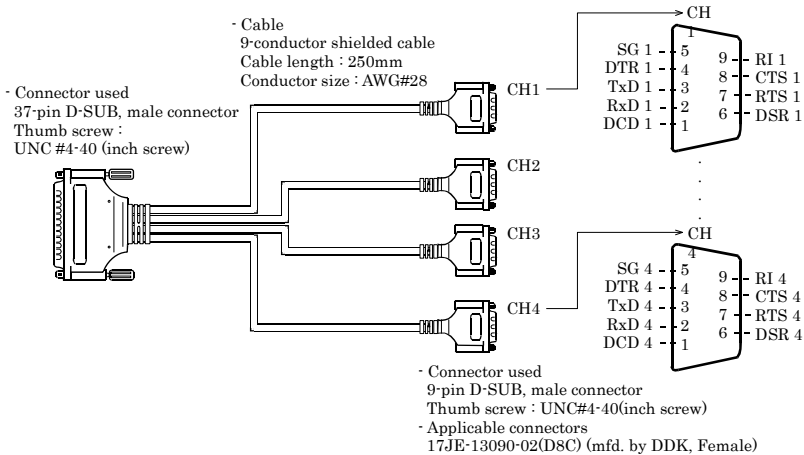

Figure 3.3. Specification of “PCE37/9PS”

Connection conversion (Option)

Connection Conversion Cable (37M→9M x 4, 250mm) : PCE37/9PS

Cable (Option)

RS-232C Straight Cable with D-SUB9P (1.8m) : RSS-9M/F

RS-232C Cross Cable with D-SUB9P (1.8m) : RSC-9F

Using the 25-pin D-SUB Connector Conversion Cables

Use a PCE37/25PS connection conversion cable (purchased separately) to connect to external devices after dividing into four 25-pin D-SUB male connector channels.

Use cable suitable for use with 25-pin D-SUB connectors (purchase separately) with the four divided connectors.

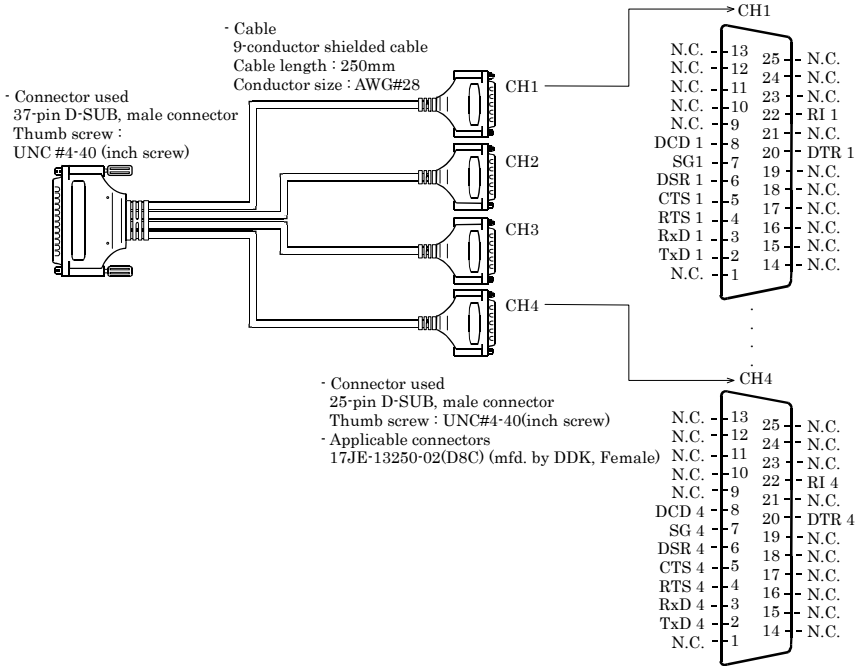

Figure 3.4. Specification of “PCE37/9PS”

Connection conversion (Option)

Connection Conversion Cable (37M→25M x 4, 250mm) : PCE37/25PS

Cable (Option)

RS-232C Straight Cable with D-SUB25P (1.8m) : RSS-25M/9F

RS-232C Cross Cable with D-SUB25P (1.8m) : RSC-25F

RS-232C Connection Conversion Straight Cable (25F→9M, 1.8m) : RSS-25M/9F

RS-232C Connection Conversion Cross Cable (25F→9F, 1.8m) : RSS-25F/9M

RS-232C Connection Conversion Cross Cable(25F→9F, 1.8m) : RSC-25F/9F

Connecting it directly from the on-board connector

If connecting an external device directly from the connector on the board, use an optional connector CN5-D37M for creating your own cables.

Pin Assignment

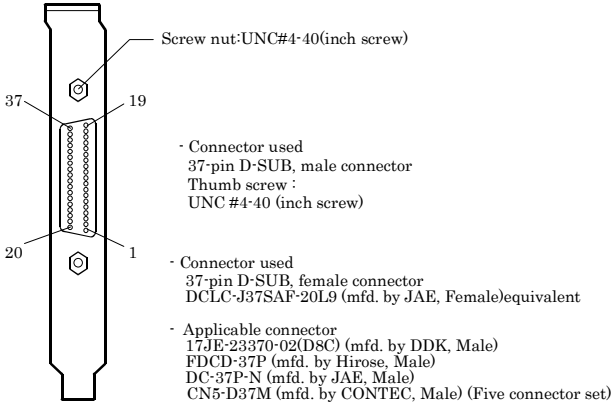

Figure 3.5. Interface Connector < COM-4P(PCI)H >

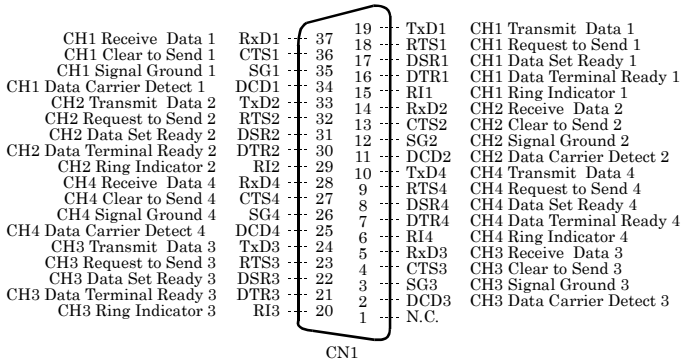

Figure 3.6. Pin Assignments of Interface Connector < COM-4P(PCI)H >

Types of Cable and Example Connections

When using an RS-232C interface, different cables are required depending on the type of device to which you are connecting (computer or modem, etc.). Check the requirements of the external device and select either a straight-through or crossed (null modem) cable as appropriate. If special treatment of the signal lines in the connector is required, ensure that this is done in accordance with the specifications.

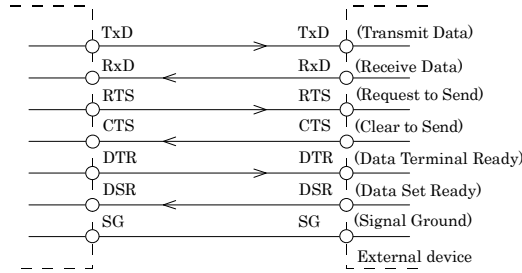

Figure 3.7. Example Connection to a Modem (Straight cable)

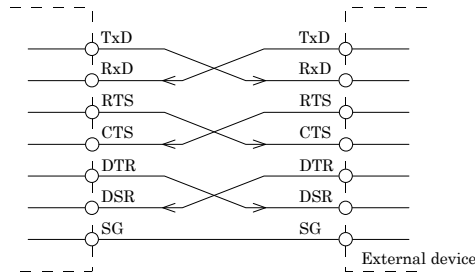

Figure 3.8. Example Connection to a PC (Cross cable)

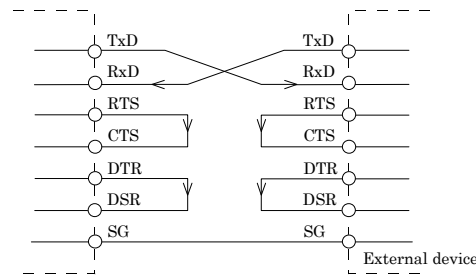

Figure 3.9. Example Connection to a Device

4. Functions

This section describes the functions of the board.

Communication Function

Serial Data Transmission

Sends and receives data in accordance with the RS-232C standard.

The baud rate for each channel can be set independently in the range 2 - 921,600bps by software.

RS-232C Control Lines

All ports include the RTS, CTS, DTR, and DSR control lines.

The lines can be controlled or monitored by software from the application

Send and Receive Data Buffers

Each channel has a separate 128-byte send and 128-byte receive buffer.

The buffers operate as FIFO buffers and help reduce the load on the CPU for high-speed communications or system operation.

The data buffer settings (Use FIFO ON/OFF and FIFO trigger size) are set by the Device Manager (under Windows 8, 7, Server 2008, Vista, XP, Server 2003, 2000) and by the API-TOOL configuration (under Windows NT, Me, 98, and 95).

The FIFO trigger size specifies the data buffer size and determines the timing for generating hardware interrupts.

Setting a large FIFO trigger size lightens the load on the CPU by reducing the number of hardware interrupts generated by sending or receiving data.

However, as data is not actually sent or received until a certain amount of data has accumulated, the timing at which the data reaches the opposing device is slightly delayed. Similarly, there is also a delay in the timing between data being received and the data being passed the application.

Alternatively, setting a small FIFO trigger size or disabling FIFO operation increases the speed of data sending and receiving but increases the load on the CPU and risks received data being missed.

As the FIFO trigger size is variable, you can adjust this setting to achieve optimum performance for your system.

Setting the Baud Rate

The output baud rate can be set by setting the appropriate value to the Baud Rate Generator register. The available setting range depends on which clock mode is used.

Clock 3 mode	:	15 - 921,600bps
Clock 2 mode	:	8 - 460,800bps
Clock 1 mode	:	4 - 230,400bps
Clock 0 mode	:	2 - 115,200bps

However, some baud rate values do not have a corresponding Baud Rate Generator register setting. If the result of substituting the baud rate into the equation below is an integer, then that baud rate can be set. If the result contains a fractional part, the baud rate cannot be set.

Clock 3 mode

$921600 \div \text{Desired baud rate} = \text{Division register setting value}$

Ex.) $921600 \div 9600\text{bps} = 96$ (As the result is an integer, this baud rate can be set.)

$921600 \div 128000\text{bps} = 7.2$ (As the result contains a fractional part, this baud rate cannot be set.)

Clock 2 mode

$460800 \div \text{Desired baud rate} = \text{Division register setting value}$

Ex.) $460800 \div 9600\text{bps} = 48$ (As the result is an integer, this baud rate can be set.)

$460800 \div 128000\text{bps} = 3.6$ (As the result contains a fractional part, this baud rate cannot be set.)

Clock 1 mode

$230400 \div \text{Desired baud rate} = \text{Division register setting value}$

Ex.) $230400 \div 9600\text{bps} = 24$ (As the result is an integer, this baud rate can be set.)

$230400 \div 128000\text{bps} = 1.8$ (As the result contains a fractional part, this baud rate cannot be set.)

Clock 0 mode

$115200 \div \text{Desired baud rate} = \text{Division register setting value}$

Ex.) $115200 \div 9600\text{bps} = 12$ (As the result is an integer, this baud rate can be set.)

$115200 \div 76800\text{bps} = 1.5$ (As the result contains a fractional part, this baud rate cannot be set.)



CAUTION

The "Driver Library API-PAC(W32)" and the "Standard COM Driver Software COM Setup Disk" from the supplied CD-ROM use "Clock mode 3". (Fixed)



CAUTION

As Visual Basic's communication control (MSComm) accepts any available baud rate settings, using the MSComm functionalities limits the rate to 115,200bps maximum. For setting the baud rate higher than 115,200bps using Visual Basic, refer to the VB sample program included in the accompanying CD-ROM "Standard COM Driver Software COM Setup Disk".

Refer to the following baud rate setting examples. Baud rates other than those listed below can also be set if they produce a valid setting value in the equation described above.

Table 4.1. Baud Rate Generator Programming Table

Output baud rate	Clock 0 mode (1.8432MHz)		Clock 1 mode (3.6864MHz)		Clock 2 mode (7.3728MHz)		Clock 3 mode (14.7456MHz)	
	Baud Rate Generator register	Setup error (%)	Baud Rate Generator register	Setup error (%)	Baud Rate Generator register	Setup error (%)	Baud Rate Generator register	Setup error (%)
2	57600	---						
4	28800	---	57600	---				
5	23040	---	46080	---				
8	14400	---	28800	---	57600	---		
15	7680	---	15360	---	30720	---	61440	---
50	2304	---	4608	---	9216	---	18432	---
75	1536	---	3072	---	6144	---	12288	---
110	1047	0.026	2094	0.026	4189	0.0022	8378	0.0022
134.5	857	0.058	1713	0.0006	3426	0.0006	6852	0.0006
150	768	---	1536	---	3072	---	6144	---
300	384	---	768	---	1536	---	3072	---
600	192	---	384	---	768	---	1536	---
1200	96	---	192	---	384	---	768	---
1800	64	---	128	---	256	---	512	---
2000	58	0.68	115	0.17	230	0.17	461	0.04
2400	48	---	96	---	192	---	384	---
3600	32	---	64	---	128	---	256	---
4800	24	---	48	---	96	---	192	---
7200	16	---	32	---	64	---	128	---
9600	12	---	24	---	48	---	96	---
14400	8	---	16	---	32	---	64	---
19200	6	---	12	---	24	---	48	---
28800	4	---	8	---	16	---	32	---
38400	3	---	6	---	12	---	24	---
57600	2	---	4	---	8	---	16	---
76800			3	---	6	---	12	---
115200	1	---	2	---	4	---	8	---
153600					3	---	6	---
230400			1	---	2	---	4	---
460800					1	---	2	---
921600							1	---

Other Functions

Channel Isolation/Bus Isolation

The communication lines for each channel are electrically isolated from each other and from the PC.

As isolation is provided between channels as well as isolation of the bus, this prevents electrical interference between channels as well as between the PC and external circuits.

This means you can safely use the boards in environments where noise is likely to be generated on the communication lines and where you are concerned about this causing incorrect operation or damage to the PC.

Surge Protection

As surge protection is provided on all RS-232C control lines, you can safely use the boards in environments where you are concerned about surges causing incorrect operation or damage to the PC.

5. About Software

The "Standard COM Driver Software COM Setup Disk" from the supplied CD-ROM provides the following functions.

- Operation under Windows and Linux.
- The serial ports can be used in the same way as the standard COM ports on the PC.
- The boards can be used for all types of serial communications such as for remote access service (RAS) and uninterruptible power supply (UPS) applications.
- Under Windows, the serial ports can be accessed using the standard Win32 API communication routines (CreateFile(), WriteFile(), ReadFile(), and SetCommState(), etc.)
- The serial ports are also compatible with the Visual Basic communication control (MSComm).
- Supports the communication class of .NET Framework (SerialPort class).
- Under Linux, the software functions as a standard Linux tty driver. The standard open(), close(), read(), and write(), etc. routines are supported.

Refer to the \PCI\Readmee.txt and \Linux\Readmee.htm files on the CD-ROM for details.

About Sample programs

Sample programs are provided in the \Samples folder on the CD-ROM. Use the sample programs for reference and testing when developing software.

Visual Basic sample programs

(1) Transmit/Receive sample

- Sends data entered from the keyboard and displays received data on the screen.
- Source folder: \Samples\Vb folder

Visual Basic 2005 sample programs

(1) Transmit/Receive sample

- Sends data entered from the keyboard and displays received data on the screen.
- Source folder: \Samples\VB.NET folder

Visual C# 2005 sample programs

(1) Transmit/Receive sample

- Sends data entered from the keyboard and displays received data on the screen.
- Source folder: \Samples \VCS folder

Visual C++ sample programs

(1) Transmit sample

- Sends data entered from the keyboard. Execute from the command prompt.
- Source folder: \Samples\Vc\Comsend.c file

(2) Receive sample

- Displays received data on the screen.
- Source folder: \Samples \Vc\Comread.c file

Uninstalling the driver software

To uninstall the driver software installed from the COM Setup Disk, follow the procedure given below. For uninstall the driver from a Linux machine, refer to the \Linux\Readmej.htm file on the bundled CD-ROM.

About the uninstall function

The install function deletes the COM-DRV driver and registry information, available from [Add/Remove Programs].

This function can be used only in Windows XP/Server 2003/2000. In other OSs, you have to uninstall the driver manually.

Windows XP, Server 2003, 2000

- (1) Open the Control Panel and launch Device Manager from the [System] applet.
- (2) Expand [Multifunction adapters] and delete [CONTEC Co., Ltd-XXXXXXXXXX] (installed hardware name).
- (3) Start [Add/Remove Programs] from the Control Panel.
- (4) Select [CONTEC COM-DRV(WDM) driver] from the list of applications, then click the [Add/Remove] button to automatically start the uninstall procedure.

Windows 8, 7, Server 2008, Vista

- (1) Open the Control Panel and launch Device Manager from the [System] applet.
- (2) Expand [Multifunction adapters] and delete [CONTEC Co., Ltd-XXXXXXXXXX] (installed hardware name). To also delete all the driver files, check [Remove this device software].

Windows Me, 98, 95



CAUTION

[CONTEC COM-DRV(WDM) driver] is not listed by [Add/Remove Programs].

Take the following steps to manually uninstall the driver software.

- (1) Start Config.exe and , then select [COM-DRV] from the [Tools] menu.
If any piece of hardware (board) has been registered, delete it. If not, leave the tool as it is.
- (2) Open the Control Panel and launch Device Manager from the [System] applet.
- (3) Delete [CONTEC Co., Ltd-XXXXXXXXXX] (installed hardware name) displayed on the [Multifunction adapters].
- (4) Start Windows Explorer.
- (5) Select [Folder Options] from the [Tools] menu.
- (6) Click the [View] tab.
- (7) Check [Show hidden files and folders] (or [Show all files]), then click [OK].
- (8) Right-click on the \Windows\Inf folder and choose [Search].
- (9) Enter the model name of the hardware used (for example, COM-2P(PCI)H) in the [Containing text:] field, then click the [Search Now] button.

Be careful not to enter text in the [Search for files or folders named:] (or [Name]) field.

- (10) Delete all the files detected by the search.
- (11) Delete files from the C:\Contec folder.
- (12) Delete ComDrv95.vxd from the \Windows\system folder.

Windows NT

Take the following steps to manually uninstall the driver software.

- (1) Delete files from the C:\Contec folder.
- (2) Delete ComDrv.sys from the \Winnt\system32\drivers folder.

Installing the API-PAC(W32) API-SIO Driver in the Windows Vista/XP/Server 2003/2000 Environment

- (1) Run SETUP.EXE from the API-PAC(W32) CD-ROM or from the file (* hereafter API-PAC(W32)) downloaded from the Contec's download site to install the API-SIO driver.
- (2) Reboot your OS, and the Hardware Wizard will be started.
- (3) During the installation, you will be prompted for an INF file. Specify the API-PAC(W32) INF folder designated for the OS and device type in use.
- (4) Run Config.exe to register the board.

[Notes]

If you install API-SIO from the API-PAC(W32) CD-ROM in Windows XP, uncheck [Search removable media (floppy, CD-ROM...)] at the [Please choose your search and installation options.] prompt. Leaving the option checked prevents the API-SIO driver from being installed normally. If you have installed it with that option checked, take the steps for "Uninstalling the Driver Software" again as described above.

CD-ROM Directory Structure

\	
- Linux	Linux device driver (for PCI boards and PC cards only)
- PCCARD	PC card related files
- PCI	PCI board related files
- ComDrv	Windows device driver and INF files, etc.
- InstDoc	Installation instructions for each OS.
- Samples	Various sample programs
- VB	Sample program for Visual Basic
- VC	Sample program for Visual C++
- VB.NET	Sample program for VisualBasic.NET (for SerialPortClass)
- VCS	Sample program for VisualC.NET (for SerialPortClass)
- USB	USB related files
- UsersGuide	Manual of hardware (PDF)
- UsersGuide	Hardware User's Guide(PDF files)
- UTILITY	Various utilities
- CommChk	Self diagnostic program (Loopback communication test)
- CTstCom	Self diagnostic program (Terminal utility)

6. About Hardware

This chapter provides hardware specifications and hardware-related supplementary information.

For detailed technical information

For further detailed technical information (“Technical Reference” including the information such as an I/O map, configuration register, etc.), visit the Contec's web site (<http://www.contec.com/support/>) to call for it.

Hardware specification

Tables 6.1 - 6.2 list the board specifications.

COM-2P(PCI)H

Table 6.1. Specification

Item	Specification
Number of channels	2ch
Interface type	RS-232C
Isolation	Channel Isolation/Bus Isolation
Isolation voltage	Channel Isolation: 500VDC, Bus Isolation: 1000VDC
Transfer method	Asynchronous serial transfer
Baud rate	2 · 921,600bps *1 *2
Data length	5, 6, 7, 8 bits 1, 1.5, 2 stop bits *1
Parity check	Even, Odd, Non-parity *1
Controller chip	162850 or equivalent (Each channel has 128-byte receive and 128-byte transmit FIFO buffers.)
Connecting distance	15m(Typ.)
Interrupt requests	1 level use *3
I/O address	Any 32-byte boundary
Power consumption	5VDC 600mA (Max.)
Operating temperature	0 · 50°C, 10 · 90%RH(No condensation)
Bus specification	PCI (32bit, 33MHz, Universal key shapes supported *4)
Dimension (mm)	121.69(L) × 105.68(H)
Connector used	9-pin D-SUB connector, DELC-J9PAF-20L9 [mfd. by JAE, M(male) type] equivalent
Weight	80g

*1 These items can be set by software.

For the "Driver Library API-PAC(W32)" and the "Standard COM Driver Software COM Setup Disk" on the supplied CD-ROM, the range is 15 · 921,600 bps.

*2 Data transmission at high speed may not be performed normally depending on the environment including the type of status of connected material of cable and environment.

*3 The interrupt signals from all channels are connected as a single interrupt signal on the PCI bus.

*4 This board requires power supply at +5 V from an expansion slot (it does not work on a machine with a +3.3V power supply alone).

COM-4P(PCI)H

Table 6.2. Specification

Item	Specification
Number of channels	4ch
Interface type	RS-232C
Isolation	Channel Isolation/Bus Isolation
Isolation voltage	Channel Isolation: 500VDC, Bus Isolation: 1000VDC
Transfer method	Asynchronous serial transfer
Baud rate	2 · 921,600bps *1 *2
Data length	5, 6, 7, 8 bits 1, 1.5, 2 stop bits *1
Parity check	Even, Odd, Non-parity *1
Controller chip	162850 or equivalent (Each channel has 128-byte receive and 128-byte transmit FIFO buffers.)
Connecting distance	15m(Typ.)
Interrupt requests	1 level use *3
I/O address	Any 32-byte boundary
Power consumption	5VDC 1000mA (Max.)
Operating temperature	0 · 50°C, 10 · 90%RH(No condensation)
Bus specification	PCI (32bit, 33MHz, Universal key shapes supported *4)
Dimension (mm)	121.69(L) x 105.68(H)
Connector used	37-pin D-SUB, female connector, DCLC-J37SAF-20L9 (mfd. by JAE) equivalent
Weight	90g

*1 These items can be set by software.

For the "Driver Library API-PAC(W32)" and the "Standard COM Driver Software COM Setup Disk" on the supplied CD-ROM, the range is 15 · 921,600 bps.

*2 Data transmission at high speed may not be performed normally depending on the environment including the type of status of connected material of cable and environment.

*3 The interrupt signals from all channels are connected as a single interrupt signal on the PCI bus.

*4 This board requires power supply at +5 V from an expansion slot (it does not work on a machine with a +3.3V power supply alone).

Board Dimensions [COM-2P(PCI)H, COM-4P(PCI)H]

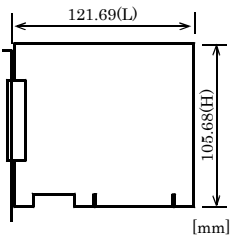

The standard outside dimension (L) is the distance from the end of the board to the outer surface of the slot cover.

COM-2P(PCI)H COM-4P(PCI)H User's Guide

CONTEC CO.,LTD.

July 2013 Edition

3-9-31, Himesato, Nishiyodogawa-ku, Osaka 555-0025, Japan

Japanese <http://www.contec.co.jp/>

English <http://www.contec.com/>

Chinese <http://www.contec.com.cn/>

No part of this document may be copied or reproduced in any form by any means without prior written consent of CONTEC CO., LTD. [07112013]

[04102003]

[07112013_rev6]

Management No. A-46-735

Parts No. LYCP224